



ENOITALIA

PRICE LIST 2023

Index

FRUIT LINE

DESTONER PULPER DELTA	5
POMEGRANADE AND PRICKLY PEAR SEMIAUTOMATIC LINE	6
DESTEMMER FOR ELDER BERRY AND ELDER FLOWER	7
Semiautomatic APPLE PROCESSING LINE	8
CENTRIFUGAL FILTER WITH PUMP	9
BELT WASHING ELEVATOR FOR FRUIT	10
MILL FOR FRUIT WITH ENGINE	11
MOTORIZED BUFFER HOPPER with level controls	12
AUTOMATIC BUFFER TANK	13
FRUIT CRUSHER with roller and blades	14
PASTEURIZERS	15
BELT PRESS	16

FILLING

DISPENSER FOR WINE	18
AUTOMATIC DISPENSER for oil, juice and wine	19
BARRELS FILLER	20
BARRELS TOP FILLER	21
GRAVITY FILLING desk type	22
GRAVITY FILLING with trolley type	23
VACUUM FILLER	24
SEMIMANUAL MONOBLOCK	25
MANUAL FILLING BB10 and PRIMO KIT <i>for Bag in Box</i>	26
SEMI-MANUAL FILLING BB12 <i>for Bag in Box</i>	27
SEMIAUTOMATIC FILLING BB20 <i>for Bag in Box</i>	28
Optional for semiautomatic filling BB20	29
AUTOMATIC FILLING BB30 <i>for Bag in Box</i>	30
AUTOMATIC FILLING BB40 <i>for Bag in Box</i>	31
AUTOMATIC FILLING AND PACKAGING BB50 <i>for Bag in Box</i>	32
Optional for filling machines BB40 e BB50	33
COMPLETE BAG IN BOX PACKING LINE	34
COMBINED FILLER for hot liquids	35
SCALE FILLING FLUIDA MVE	36
AUTOMATIC DOSING SYSTEM OPTIMA	37
ACCESSORIES TO TRANSFER LIQUID	38-39

GRAPE PROCESSING EASY LINE

CRUSHER MICROENO, MINIENO, ENO 1 e ENO 2	41
CRUSHER DESTEMMER ENO 3	42
DESTEMMER ENO 10	43
CRUSHER DESTEMMER ENO 15	44
CRUSHER DESTEMMER SEMICENTRIFUGAL ENO 20	45
DESTEMMER CRUSHER SEMICENTRIFUGE ARNO	46
DESTEMMER CRUSHER SEMICENTRIFUGE JOLLY	47

GRAPE PROCESSING PROFESSIONAL LINE

DESTEMMER CRUSHER SEMICENTRIFUGE JOLLY AR	49
DESTEMMER CRUSHER CENTRIFUGE JOLLY 50/A	50
DESTEMMER CRUSHER CENTRIFUGE BETA	51
DESTEMMER CRUSHER SEMICENTRIFUGE JOLLY 40 MV	52
DESTEMMER CRUSHER CENTRIFUGE JOLLY 40 REVERSE	53
DESTEMMER CRUSHER INOX JOLLY 60 MV	54
DESTEMMER CRUSHER INOX JOLLY 60 MV with integrated sorting line	55
DESTEMMER CRUSHER JOLLY 60 RS	56
DESTEMMER CRUSHER JOLLY 100 MV	57
DESTEMMER CRUSHER JOLLY REVERSE	58

DESTEMMER CRUSHER JOLLY REVERSE with automatic sorting table	59
DESTEMMER CRUSHER JOLLY REVERSE with vibrating sorting table	60
MOTORIZED CRUSHER	61
AUTOMATIC STALKS SHATTER with belt	62
SORTING TABLE NC	63
SORTING AND LOADING LINE TC	64
BELT ELEVATOR SC	65
SCREW ELEVATOR U-200	66
PNEUMATIC PRESS GAMMA	67
MANUAL AND AUTOMATIC SVINATORE	68
AUTOMATIC WASHING TANK	69
MOTORIZED MIXER	70
CARTON FILTER VIRGILIO and MINI VIRGILIO	71
FILTER 40X40	72

PUMPS

ELLIPTICAL ROTOR PUMP with loading hopper	74
MONO PUMP with loading hopper	75
MONO PUMP FOR LIQUID	76
PERISTALTIC PUMP with loading hopper	77
PERISTALTIC PUMP without loading hopper	78
TANKS WASHING SYSTEM	79
COAXIAL PUMP without switch and without trolley	80
COAXIAL PUMP with switch without trolley	81
COAXIAL PUMP with trolley and switch	82
PUMP ON TROLLEY with belt driven	83
PUMP ON TROLLEY with speed variator	84
PUMP ON TROLLEY with electronic inverter	85
OPTIONAL and SPARE PART PUMP EURO	86
CENTRIFUGAL PUMP WITH INOX BODY	87
EUROFILL for dosing and counting liquids	88
PUMPS FITTING	89
PACKING AND SHIPPING	90
CONDITIONS OF GUARANTEE	91



ENOITALIA
ENOLOGICAL EQUIPMENTS



FRUIT LINE



DESTONER PULPER DELTA



Video



DELTA 1



Cod. 804

DELTA 2



DELTA ZERO

STANDARD FEATURES

- Engine and emergency stop
- Structure in AISI 304 stainless steel
- Stainless steel shaft with adjustable rubber blades
- Electrical system with emergency stop
- Stainless steel loading screw
- Stainless steel mesh with 0.8-12mm holes
- Thermal protection for the engine
- Frequency inverter 7,5 Kw and automatic loading hopper (as standard on cod. 804)

MODEL		
Cod.	Description	€
802	Destoner DELTA ZERO	
801	Destoner DELTA 1 Three-phase	
803	Destoner DELTA 2 Three-phase	
804	Destoner DELTA 2 for tropical fruit application	

OPTIONAL		
Cod.	Description	€
4260	Additional internal basket for DELTA 0 with hole size 0,8 - 12 mm	
4261	Additional internal basket for DELTA 1 with hole size 0,8 - 12 mm	
4262	Additional internal basket for DELTA 2 with hole size 0,8 - 12 mm	
4263	Single rubber plate for DELTA 0	
4264-1	Single rubber plate for DELTA 1	
4264-2	Single rubber plate for DELTA 2	
4265	Internal basket for DELTA ZERO with hole 0,6 mm	
4266	Internal basket for DELTA 1 with hole 0,6 mm	
4250	Electronic speed variator for Delta 1/2 (max 5,5 Kw)	
4251	Increased difference for 5,5 Kw engine for Delta 2	
4252	Basket's seal fol Delta zero	
4253	Basket's seal fol Delta 1	
4254	Basket's seal fol Delta 2	

MODEL	ENGINE HP (Kw)	POWER	STONE UNLOADING HEIGHT	JUICE UNLOADING HEIGHT	LOADING HEIGHT	CAPACITY	DIMENSION mm	WEIGHT
802	1,5 (1,1)	Single-phase / Three-phase	400 mm	300 mm	1300 mm	550 Kg/h	1500x800x1450	80 Kg
801	4 (3)	Three-phase	480 mm	370 mm	1420 mm	1200 Kg/h	1400x700x1420	150 Kg
803	5,5 (4)	Three-phase	480 mm	370 mm	1620 mm	2000 Kg/h	1800x850x1850	250 Kg
804	7,5 (5,5)	Three-phase	480 mm	370 mm	1620 mm	3000 Kg/h	1800x850x2200	300 Kg



POMEGRANADE AND PRICKLY PEAR SEMIAUTOMATIC LINE



Video

Cod. 4271+4278



Cod. 9925



Cod. 3210T



Cod. 4277



Cod. 801

STANDARD FEATURES (4271 - 3210T)

- Structure in stainless steel AISI 304
- Aluminum rollers
- 40 mm hose fittings for cod. 4271 and 50 mm for cod. 3210T
- Removable and interchangeable internal basket
- Accident prevention protections

MODEL		
Cod.	Description	€
4271	Crusher separate for whole fruit - stainless steel HP2 fixed rollers	
4278	Inox support for crusher with loading hopper	
3210T	Jolly 30 destemmer crusher for pomegranates with Euro 50 pump	
9928	Motorized storage tank with Euro40 pump and automatic operating probes	
801	Pulper for pomegranate arils - model DELTA 1	
4277	Centrifuge gravity filter with automatic draining pump	

OPTIONAL

Cod.	Description	€
9172	Electronical inverter for cod. 3210T	
9173	Electronical inverter for EURO pump	

MODEL	ENGINE Kw	POWER	CAPACITY	DIMENSION mm	WEIGHT
4271	1,5	220V-50Hz / 380V-50Hz	1200 Kg/h	1210x600x630	65 Kg
3210T	1,8	380V-50Hz	3000 Kg/h	1280x900x900	150 Kg



DESTEMMER FOR ELDER BERRY AND ELDER FLOWER



OUTLET



Cod. 4278



STANDARD FEATURES

- Structure in AISI 304 stainless steel
- Special stainless steel internal basket
- Stainless steel feeding screw
- HP1 engine

MODEL

Cod.	Description	€
4279	Elderberry separator	
4278	Inox support for crusher with loading hopper	

OPTIONAL

Cod.	Description	€
004/S	Electronic speed variator	
009	Stainless steel support for cod. 4279 open version (as an alternative to 4278)	

MODEL	ENGINE HP (Kw)	PRODUCTION	DIMENSION	WEIGHT
4279	HP1 (0,75)	800-1000 Kg/h	120x600x690 mm	53 Kg



Semiautomatic APPLE PROCESSING LINE



Video

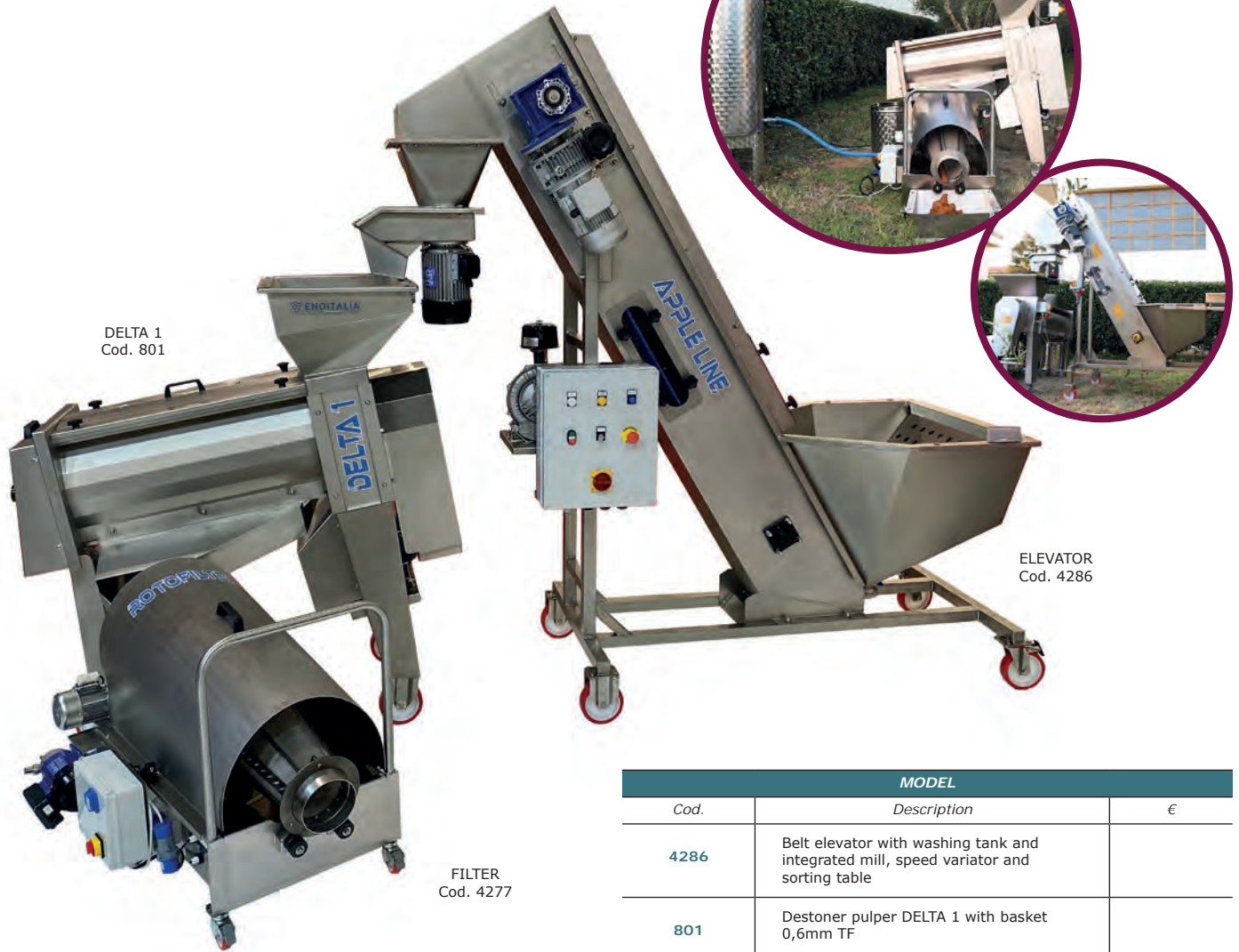

DELTA 1
Cod. 801

FILTER
Cod. 4277

ELEVATOR
Cod. 4286

STANDARD FEATURES

- Structure in AISI 304 stainless steel
- Stainless steel support trolley on 4 wheels
- Speed variator for cod. 4286
- Total drain valve in stainless steel
- Mill special type HP4, openable and removable mill
- Control panel with emergency stop
- Enos model liquid pump
- Productivity 35% juice, 55% pulp

MODEL

Cod.	Description	€
4286	Belt elevator with washing tank and integrated mill, speed variator and sorting table	
801	Destoner pulper DELTA 1 with basket 0,6mm TF	
4277	Automatic centrifuge filter with pump and buffer 0,3 mm	

OPTIONAL

Cod.	Description	€
4274	Centralized panel control to connect pulper, filter and elevator	

MODEL	ENGINE Kw	POWER	UNLOADING HEIGHT	LOADING HEIGHT	CAPACITY
4286-801-4277	9	Three-phase	1700 mm	600 mm	800-1000 Kg/h



CENTRIFUGAL FILTER WITH PUMP



STANDARD FEATURES

- Structure in AISI 304 stainless steel
- Support trolley in stainless steel on 4 wheels
- Conical 0.3 mm filter
- Single-phase power for filter
- Level probes
- Stainless steel centrifugal pump ENOS 20
- Control panel with emergency stop

MODEL

Cod.	Description	€
4277	Centrifuge gravity filter with automatic draining pump	

OPTIONAL

Cod.	Description	€
4291	Difference for Three-phase power supply only with cod. 9174	
9174	Difference for volumetric pump EURO 20	

MODEL	ENGINE (KW)	POWER	LOADING HEIGHT	CAPACITY	DIMENSION	WEIGHT
4277	0,52	Single-phase	410 mm	1000 Kg/h	800x1080x750 mm	70 Kg



BELT WASHING ELEVATOR FOR FRUIT



Video



Cod. 4286 + 4287



Cod. 4286 + 4289

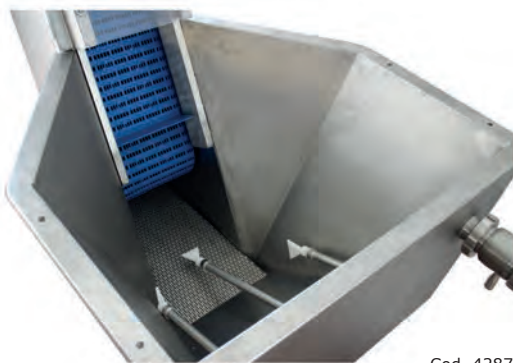

Cod. 4287



STANDARD FEATURES

- Structure in AISI 304 stainless steel
- Support trolley in stainless steel on 4 wheels
- Speed variator
- Removable internal basket
- Total drain with inox ball valve
- Control panel with emergency stop
- Fruit rinsing station
- Removable protection for quick cleaning
- Removable sorting table 1mt lenght

MODEL

Cod.	Description	€
4281	Belt elevator and washing with speed variator and sorting table	
4286	Belt elevator with washing tank and integrated mill, speed variator and sorting table	

OPTIONAL

Cod.	Description	€
4287	System for storage tank barboter	
4289	Extension for installation with Delta 2 (h.350 mm)	

MODEL	ENGINE HP (Kw)	POWER	UNLOADING HEIGHT	LOADING HEIGHT	CAPACITY	DIMENSION mm	DIMENSION HOPPER mm	WEIGHT
4281	1 (0,75)	Three-phase	1880 mm	910 mm	3000 Kg/h	2300/3000x900x2300h	870x840	230 Kg
4286	1 (0,75) + 4 (3)	Three-phase	1450 mm	910 mm	1000 Kg/h	2300/3000x900x2300h	870x840	260 Kg



MILL FOR FRUIT WITH ENGINE



Video

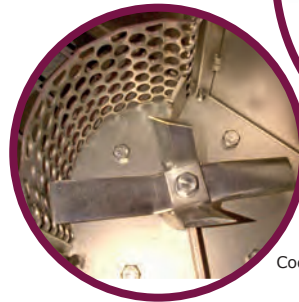

Cod. 4267 + 4269 + 4268

STANDARD FEATURES

- Structure in AISI 304 stainless steel
- Adjustable feet
- Emergency stop system on opening
- HP 2,5 single-phase 220V 50hz or three-phase 380V electric motor
- Emergency stop
- Interchangeable pressing sieve, holes available: 3,8,12mm (standard)

MODEL

Cod.	Description	€
991	MILL FOR FRUIT M-100	

OPTIONAL

Cod.	Description	€
4267	Special sieve with holes 3 or 8 mm	
4268	KIT replace blades	
4269	Mill scraper	
9175	Engine HP4	

MODEL	ENGINE HP (KW)	HOPPER DIMENSION	LOADING HEIGHT	UNLOADING HEIGHT	CAPACITY	DIMENSION mm	WEIGHT
M100	2,5 (1,8) MF/TF	610 mm	1400 mm	520 mm	1500-1800 Kg/h	1100x610x1400	45 Kg
						packing: 630x580x700	



MOTORIZED BUFFER HOPPER with level controls



Cod. 9928

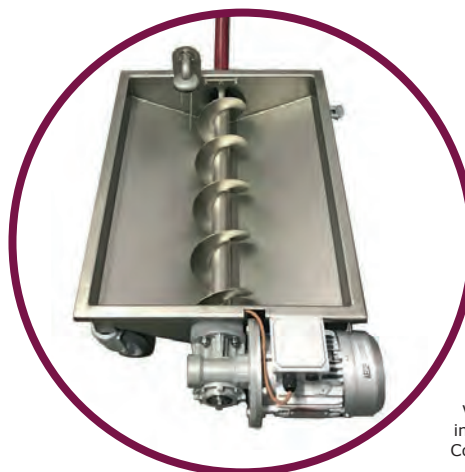

Version increased
Cod. 9929



Cod. 992

MODEL		
Cod.	Description	€
992	Motorized loading hopper with pump EURO 40	
9928	Automatic loading hopper with pump and level sensor	

OPTIONAL		
Cod.	Description	€
9929	Difference for larger version, with tank capacity 60 lt	

STANDARD FEATURES

- EURO 40 model pump with rotation inverter three-phase / single-phase
- Motorized buffer with 0.37kw engine, capacity 10 lt
- DIN 40 connection fitting
- Stainless steel trolley

MODEL	ENGINE HP (Kw)	HOPPER DIMENSION	CAPACITY PULP	DIMENSION	WEIGHT
992	hp 2,5 kw 1,87 MF/TF	240x320x370 mm	2000 Kg/h	960x900x620 mm	28 Kg
9928	hp 2,5 kw 1,87 TF	240x320x370 mm	2000 Kg/h	520x1200x930 mm	45 Kg



AUTOMATIC BUFFER TANK



STANDARD FEATURES

- Frame in stainless steel with conical floor
- Internal filter removable in stainless steel
- Panel control single phase with electronic level sensor
- Centrifuge pump ENOS in stainless steel
- Total drain valve
- 4 wheels with brakes

MODEL

Cod.	Description	€
4273	Automatic buffer tank with pump ENOS 20 in stainless steel single-phase	
4275	Automatic buffer tank with single-phase panel and plug for external pump (pump not included)	
4276	Automatic buffer tank with three-phase panel and plug for external pump (pump not included)	

OPTIONAL

Cod.	Description	€
5201	Euro pump 20 Single-phase	

MODEL	FITTING	HOPPER DIMENSION	HOPPER HEIGHT	CAPACITY	WEIGHT
4273	25 mm	600x700 mm	390 mm	130 lt	36 Kg



FRUIT CRUSHER with Aluminium roller and Inox blades



ENO 1 - Hopper Inox, with engine 1 HP



Safety protection

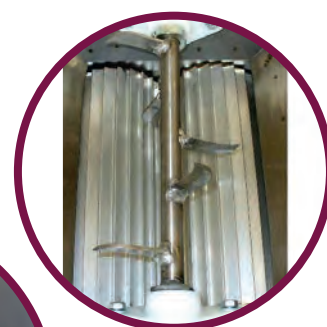

MODEL K



MODEL KP



MICROENO, MINIENO, ENO 1 - Hopper Inox with flywheel

STANDARD FEATURES

- Self-adjusting aluminum rollers
- Flywheel (for models with flywheel)
- Motor with emergency stop (HP1 engine for code 504KP)
- Agitator with stainless steel blades

For grape crushers see p. 41

MODEL

Cod.	Description	€
471 K	MICROENO - smalted hopper	
491 K	MINIENO - smalted hopper	
517 KP	MINIENO - hopper Inox	
504 KP	ENO 1 - with ENGINE hopper Inox safety protection	

OPTIONAL

Cod.	Description	€
006	Safety protection (included on all motorized crusher)	

MODEL	ENGINE HP (Kw)	HOURLY PRODUCTION	HOPPER	DIMENSION mm		WEIGHT		ROLLER LENGHT
				with flywheel	with engine	with flywheel	with engine	
MICROENO	---	300 - 500 Kg/h	555x455 mm	860x365x470	---	14 Kg	---	150 mm
MINIENO	---	500 - 700 Kg/h	650x470 mm	1000x390x490	---	18 Kg	---	220 mm
ENO 1	1 (0,75)	500 - 700 Kg/h	850x560 mm	1210x580x350	1210x500x570	22 Kg	33 Kg	220 mm



PASTEURIZERS



300 / 500 lt

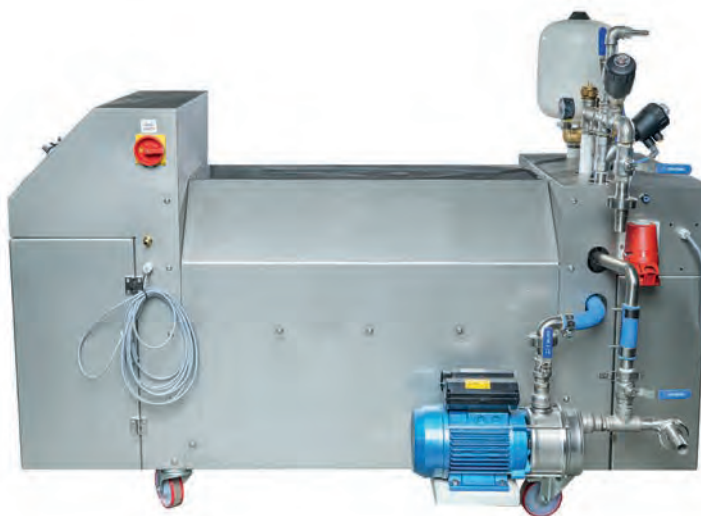

500 / 1000 lt



STANDARD FEATURES

- EPDM impeller pump
- Oil burner (on request: natural gas burner for 500lt / 1000lt)
- Support platform in stainless steel
- Control panel for temperature setting

MODEL		
Cod.	Description	€
500LT	Pasteurizer 500 lt/h	
1000LT	Pasteurizer 1000 lt/h	
300LT	Pasteurizer 300 lt/h	
500LT	Pasteurizer 500 lt/h	

MODEL	HOURLY PRODUCTION	DIESEL CONSUMPTION	BURNER CAPACITY	ELECTRICITY SUPPLY	ELECTRIC POWER	JUICE ENTRY	JUICE EXIT	DIMENSION mm
500LT	500 lt/h 80°C	8 Kg/h	95 kw	230V/50 MF	1 kw	DIN 25	DIN 20	2050x750x1170
1000LT	1000 lt/h 80°C	10 Kg/h	95 kw	230V/50 MF	1 kw	DIN 25	DIN 25	2050x750x1170
300LT	300 lt/h 80°C	-	-	TF	20 kw	DIN 25	DIN 25	925X913X1470
500LT	500 lt/h 80°C	-	-	TF	30 kw	DIN 25	DIN 25	925X913X1470



BELT PRESS

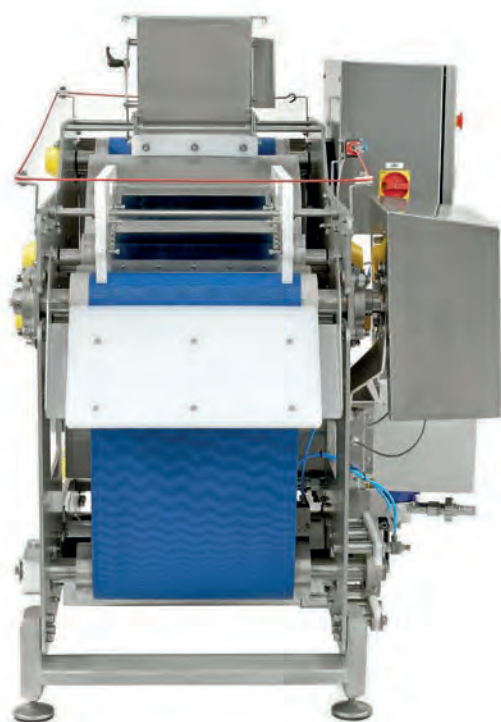
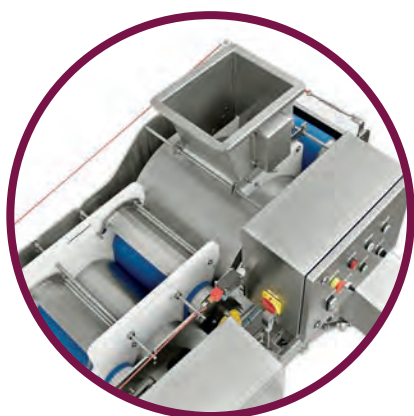

STANDARD FEATURES

- Integrated filtration sieve
- High pressure washer
- integrated pump
- Buffer tank for liquid
- Double PVC belt
- Pneumatic opening (only mod. 800 e 1200)
- Juice percentage 75%

MODEL

Cod.	Description	€
8010	Belt press 400	
8011	Belt press 800	
8012	Belt press 1200	

OPTIONAL

Cod.	Description	€
8110	Replacement belt 400	
8112	Replacement belt 800	
8113	Replacement belt 1200	

MODEL	CAPACITY Kg/h	ENGINE Kw	POWER	BELT WIDTH cm	DIMENSION	UNLOADING HEIGHT
8010	400	1,1	TF 400 V+N	40	1450x1064x1340	600
8012	800	1,1	TF 400 V+N	50	1995x1225x1350	570
8013	1200	1,1	TF 400 V+N	60	1995x1325x1350	570



FILLING



DISPENSER FOR WINE

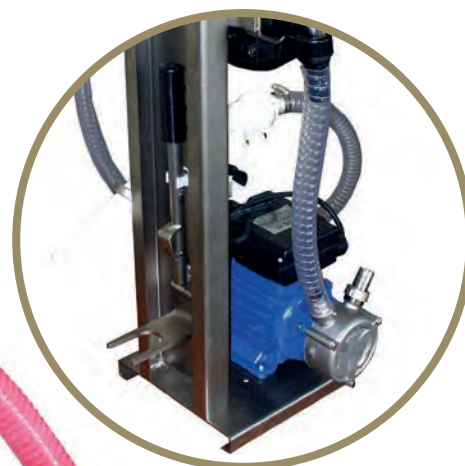

KIT for filling Bag in Box
Cod. 9024

STANDARD FEATURES

- ENOS 20/25 stainless steel centrifugal pump
- Digital flow meter model ENO 24
- Polypropylene filling gun (not MOCA certified)
- Food-grade PVC pipes
- Support stainless steel frame without wheels
- 20 V, 50 Hz single-phase power supply

MODEL

Cod.	Description	€
9022	Dispenser - with pump ENOS 20 Inox	
9023	Dispenser - with pump ENOS 25 Inox	

OPTIONAL

Cod.	Description	€
9024	KIT for filling bag in box, with manual closing system	
7108	Filling gun in stainless steel as an alternative to the polypropylene model	

MODEL	PRODUCTION	POWER (Kw)	DIMENSION	WEIGHT
9022	1600 lt/h	0,33 Kw	220x300x600 mm	15 Kg
9023	2460 lt/h	0,35 Kw	220x300x600 mm	17 Kg



AUTOMATIC DISPENSER for oil, juice and wine



Cod. 9350 + 7103



Cod. 9350 + 7107

STANDARD FEATURES

- Volumetric pump EURO 20 with rubber impeller
- Fitting DIN 20/25
- Cable for electricity 220V 50hz singlephase
- Stainless steel support without wheels
- Stainless steel pressure tank, with no-foam valve
- Automatic pressure switch
- One way inox valve
- Rubber pipe

MODEL

Cod.	Description	€
9350	Automatic dispenser with pump, pressure switch, inox storage unit and support frame	

OPTIONAL

Cod.	Description	€
7103	Digital flow meter ENO 24 for wine	
7107	Digital flow meter ENO 400 for oil and viscous juice	
9354	Inox trolley	
9024	KIT for filling bag in box, with manual closing system	

MODEL	POWER Kw	POWER	CAPACITY	DIMENSION	WEIGHT
9350	0,37	220V/50Hz MF	1000 lt/h	240x300x430 mm	20 Kg



BARRELS FILLER



Cod. 7112

Cod. 93508

STANDARD FEATURES

- Volumetric pump EURO 30, connection DIN25
- Stainless steel trolley
- Stainless steel pressure tank, with no foam valve
- One way stainless steel valve
- Filling gun with adjustable ending DIN25
- 5 meters of rubber hose diameter 20 mm
- Flow meter ENO 24

MODEL

Cod.	Description	€
9358	Manual filler three-phase	
	For dosing and counting liquids see EUROFILL pag. 88	

OPTIONAL

Cod.	Description	€
9357	Single-phase filling kit consisting of electronic condenser and separate control panel	

MODEL	POWER Kw	CAPACITY	DIMENSION	WEIGHT	FITTING
9358	0,48 TF	4500 lt/h	900x500x530 mm	26 Kg	DIN 25



BARRELS TOP FILLER



Cod. 7111



STANDARD FEATURES

- Stainless steel storage tank 150lt with anti-dust cover
- Electric pump EURO 20 with automatic pressure switch
- Tank filling and emptying valve
- Stainless steel trolley
- Stainless steel gun for top filling with return-bypass 7111
- Flexible rubber pipes from 5 mt

MODEL

Cod.	Description	€
9160	Barrels top filler equipment	

OPTIONAL

Cod.	Description	€
7103	Flow meter ENO 24 for wine	

MODEL	ENGINE Kw	POWER	DIMENSION	WEIGHT	FITTING
9160	0,37	Single-phase / Three-phase	1500x800x1400	50 Kg	DIN 20



GRAVITY FILLING desk type



Video

9301 + 9317 + 9327



HOT LIQUID VERSION



Standard version and mod. 9324



Cod. 9325



Cod. 9327

MODEL		
Cod.	Description	€
9301	Desk type with 4 filling heads without pump and level sensor	
9302	Desk type with 6 filling heads without pump and level sensor	
OPTIONAL		
Cod.	Description	€
9310	Mechanical level sensor in inox	
9311	Electronic level sensor, with connection for pump single-phase	
9318	Electronic level sensor, with connection for pump three-phase	
9312	Centrifuge pump in inox model ENOS 20	
9313	Volumetric pump EURO 20 with rubber impeller	
9315	Liquid inlet solenoid valve. Only with electric float cod. 9311	
9316	Antifoam inox valve for beer use	
9317	Difference for couple filling heads Ø 17 mm for filling viscous liquids (oil)	
9324	Difference for couple filling head for 110 mm height	
9305	ATEX KIT: Composed of level sensor and automatic pump	
9320	HOT LIQUID KIT: for filling hot liquids consisting of a thermometer and anti-condensation cover	
9345-G	Three-way pneumatic solenoid valve for code 9151 included electronic floating switch singlephase. Only cod. 9311	
9323	Manual valve for nitrogen injection	
9325	Difference for larger conical gasket for inlet diameter 27-40 mm (one unit)	
9327	Difference for flat gasket maximum bottle diameter 54 mm (one unit)	
9335	KIT for filling PET and PVC cans	
7201	Kit oring for each single head	

STANDARD FEATURES

- Structure in stainless steel, scotch brite outside, BA inside
- Filling head 15mm, connection DIN 15
- Drain valve in AISI 316
- One way inox valve
- Level marker in trogamid
- Diameter max inlet bottle neck 27 mm On demand max 40 mm or flat
- Height max inlet bottle 80 mm. On demand max 110 mm
- Adjustable and inclinable bottle support
- Adjustable feet

MODEL	N° FILLING HEADS	Ø FILLING HEADS	CAPACITY TANK	CAPACITY	DIMENSION	WEIGHT
9301	4	15 mm	45 lt	670 lt/h	580x1070x500 mm	45 Kg
9302	6	15 mm	66 lt	980 lt/h	860x1070x500 mm	57 Kg



GRAVITY FILLING with trolley type



Video



STANDARD FEATURES

- Structure in stainless steel, scotch brite outside, BA inside
- Filling head 15mm, connection DIN 15
- Drain valve in AISI 316 inox
- Pyramid platform in stainless steel with wheels
- Level marker in trogamid
- Diameter max inlet bottle 27 mm. On demand max 40 mm or flat
- Max height of bottle inlet level 80 mm. On demand max 110 mm
- Adjustable and inclinable bottle support

MODEL

Cod.	Description	€
9303	Trolley type with 4 filling heads without pump and level sensor	
9304	Trolley type with 6 filling heads without pump and level sensor	
9306	Trolley type with 12 filling heads without pump and level sensor	

OPTIONAL

Cod.	Description	€
9310	Mechanical level sensor in inox	
9311	Electronic level sensor, with connection for pump single-phase	
9318	Electronic level sensor, with connection for pump three-phase	
9312	Centrifuge pump in inox model ENOS 20	
9313	Volumetric pump EURO 20 with rubber impeller	
9314	Carton filter 20x20	
9315	Electric valve for inlet circuit. Alone with electric float cod. 9311	
9316	Antifoam inox valve for beer use	
9317	Difference for couple of filling heads Ø 17 mm for filling viscous liquids (oil)	
9324	Difference for couple filling head for 110 mm height	
9305	ATEX KIT: Composed of level sensor and automatic pump AISI 316	
9320	HOT LIQUID KIT: for filling hot liquids consisting of a thermometer and anti-condensation cover	
9345-G	Three-way pneumatic solenoid valve for code 9151 included electronic floating switch singlephase. Cod. 9311	
9323	Manual valve for nitrogen injection	
9325	Difference for larger conical gasket for inlet diameter 27-40 mm (one unit)	
9327	Difference for flat gasket maximum bottle diameter 54 mm (one unit)	
9328	Cleaning system 4 filling heads	
9329	Cleaning system 6 filling heads	
9335	KIT for filling PET and PVC cans	
7201	Kit oring for each single head	

MODEL	N° FILLING HEADS	Ø FILLING HEADS	TANK CAPACITY COLLECTION	CAPACITY	DIMENSION	WEIGHT
9303	4	15 mm	45 lt	670 lt/h	580x1800x900 mm	80 Kg
9304	6	15 mm	66 lt	980 lt/h	860x1800x900 mm	100 Kg
9306	12	15 mm	66 lt	1960 lt/h	860x1800x1100 mm	120 Kg



VACUUM FILLER



Video



Cod. 9380 + 9140



Kit Mignon

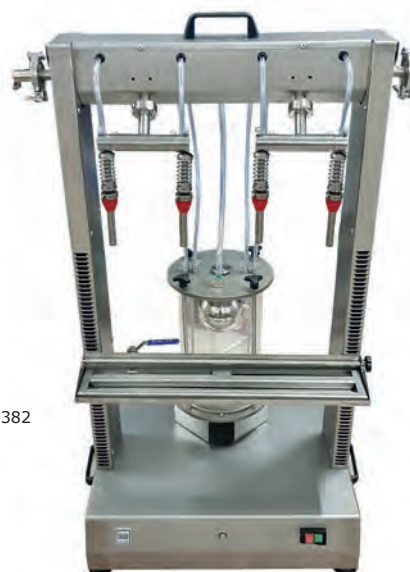

Cod. 9380 + 9382

STANDARD FEATURES

- Structure in AISI 304 stainless steel
- Vacuum pump
- Gauge
- Filling speed regulator
- Electrical panel with electronic circuit breaker
- filling head 15mm diameter
- DIN 15 fitting for piping connection
- Storage tank with stainless steel float and total drain valve
- Maximum bottle height: 330mm
- Maximum internal bottle height: 80mm

MODEL

Cod.	Description	€
9380	Vacuum filler	

OPTIONAL

Cod.	Description	€
9140	Inox trolley	
9381	Mignon kit in stainless steel , made by 2 heads, minimum capacity 5ml	
9382	Extention legs in stainless steel for filling bottle higher than 330mm	
9386	Replacement cylinder	

MODEL	FILLING HEAD NUMBER	Ø FILLING HEAD	BOTTLE	CAPACITY	DIMENSION	POWER	WEIGHT
9380	4	15 mm	0,2 a 5 lt	500 lt/h	600x800x1100 mm	220V 50/60 Hz	40 Kg



SEMIMANUAL MONOBLOCK AND CORKING

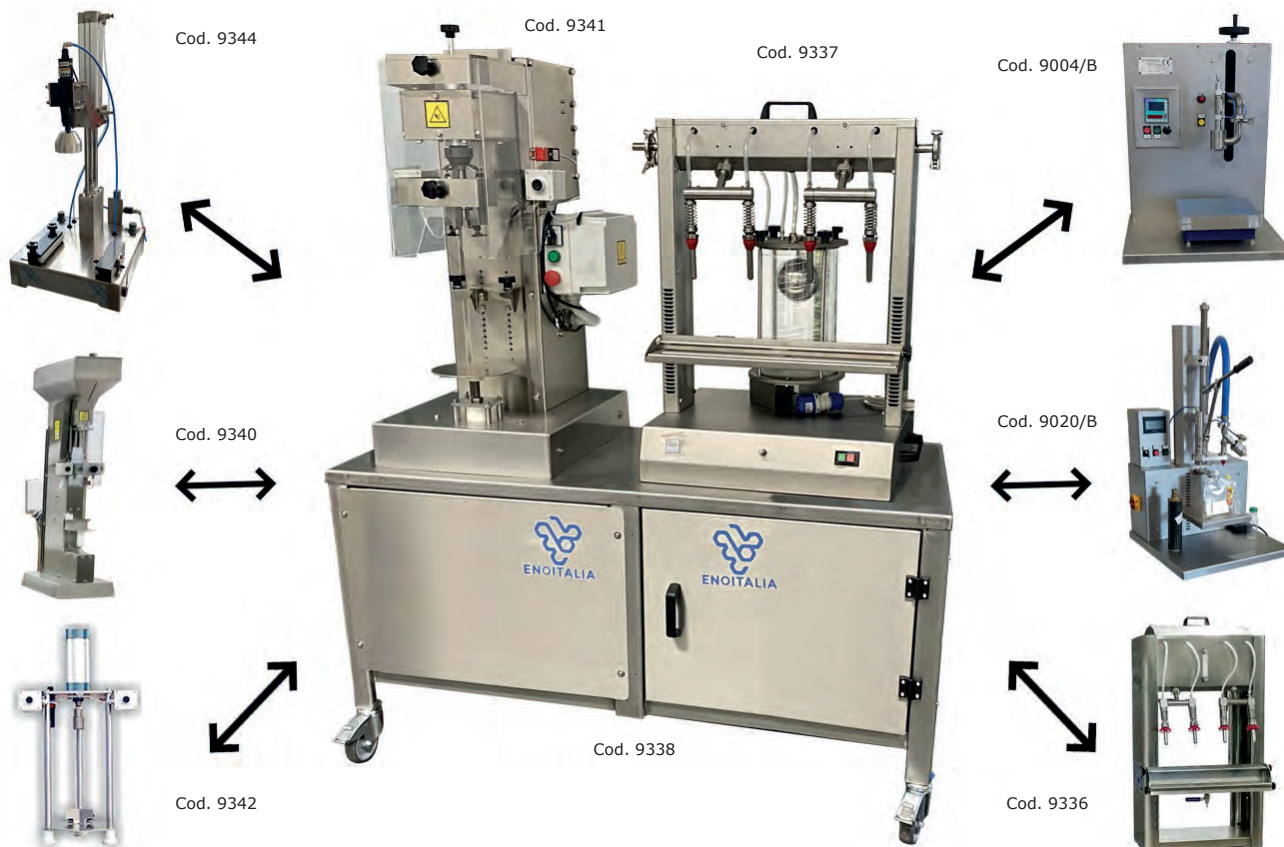

STANDARD FEATURES

- Structure in AISI 304 stainless steel
- 4 wheels, 2 of which with locking brake
- Lower shelf in stainless steel
- Possibility of installing a labeling station (only with code 9339)

OPTIONAL

Cod.	Description	€
9312	Centrifuge pump in inox model ENOS 20	
9313	Volumetric pump EURO 20 with rubber impeller	
9314	Carton filter 20x20	
9150	Oilless / silenced compressor	
9406	Integrated blower unit two heads	

MODEL

Cod.	Description	€
9336	Gravity filler desk type 4 filling heads + electronic float	
9337	Vacuum filler desk type	
9004/B	Filling machine for viscous liquids FLUIDA	
9020/B	Automatic dosing machine OPTIMA	
9338	Stainless steel desk 1400 mm	
9339	Stainless steel desk 2000 mm	
9340	Pneumatic corking desk type with automatic cap loading hopper (caps diameter 22-26 mm. Height of caps max 50 mm)	
9343	Motorized corking desk type with automatic hopper for loading caps, vacuum system, nitrogen injection system (caps diameter 22-26 mm, caps height max 50 mm)	
9341	Screw corking desk type with 3 rollers for threadings and sealings on capsules 18-35 mm	
9342	Pneumatic corking desk type for crown corks with manual loading	
9344	Corker for caps Twist Off	



MANUAL FILLING BB10 and PRIMO KIT for Bag in Box



Cod. 9005



Cod. 9010



Cod. 9007

STANDARD FEATURES

- Stainless steel filling gun
- Adjustable support for the bags
- Closing system for taps
- Digital flow meter with calibration. Max max 7000 L/h
- Pvc fitting
- Stainless steel desk with adjustable legs
- Maximum temperature 80 C°

MODEL

Cod.	Description	€
9010	Primo Kit - composed of: inox filling gun; inox support, digital flow meter	
9005	Filling machine BB10	

OPTIONAL

Cod.	Description	€
9007	Inox support for BIB (customized for minimum 20 pcs)	
9051	Oil kit for BB10 composed of flow meter ENO 400, pipe in rubber (minimum 0,3 bar pressure)	

MODEL	FITTING	CAPACITY 10 lt/h	DIMENSION	WEIGHT
9010	Ø 20 mm	50	300x150x200 mm	5
9005	Ø 20 mm	50	600x600x700 mm	25



SEMI-MANUAL FILLING BB12 for Bag in Box



Video



Cod. 9041 + 9140



Cod. 9151



Cod. 9040

STANDARD FEATURES

- Panel control with PLC to program capacity and calibration
- Digital flow meter max 7000 L/h
- Inox desk , with adjustable and removable support, 4 adjustable feet
- Filling head in stainless steel
- Pulsar valve for manual injection of nitrogen
- Blocking system for filling head
- Drop collection support
- Automatic start and stop for an external pump
- Double semiautomatic system to open and close tap
- Fitting d.20mm
- Capacity to fill flexible bags or Pouch (high or low type) since 1 lt capacity
- Capacity to fill rigid cans rectangular type or circular type (maximum 25cm diameter)
- S/s fitting for cleaning circuit (CIP)

MODEL

Cod.	Description	€
9040	Semi-manual filling BB12 - without pump	
9041	Semi-manual filling BB12 - with pump EURO 20	
9044	Semi-manual filling BB12 - with pump ENOS 20 Inox	

OPTIONAL

Cod.	Description	€
9142	Kit for filling OIL (max. capacity 1500 lt/h)	
9143	HOT LIQUID KIT: composed of sensor for filling hot juices 100 ° C non-viscous + pneumatic anti-drip valve	
9146	VACUUM KIT with pulser manual valve (air needed min 3 bar)	
9150	Silenced oilless air compressor	
9140	Inox trolley with support for pump and compressor	
9151	Buffer tank 45 liter, with 2 level sensor for connection with a pasteurizer	

MODEL	POWER	FITTING	CAPACITY 3 lt/h	CAPACITY 5 lt/h	CAPACITY 10 lt/h	CAPACITY 20 lt/h	DIMENSION	WEIGHT
9040/41/42/44	220V 50/60 Hz	Ø 20/25 mm	180	150	100	40	740x900x720 mm	50 Kg



SEMIAUTOMATIC FILLING BB20 for Bag in Box



Video

Cod. 9318



Cod. 9018 + 9343 + 9151

STANDARD FEATURES

- PLC panel control touch screen type, multilanguage multiprogram
- Electromagnetic sensor Burkert type, for cold liquid (like wine / water)
- Vacuum and Nitrogen system
- Automatic air piston for blocking the filling head
- Impeller pump HP 1,5 with by-pass, model EURO 30, capacity 4500 lt/h
- Silenced air compressor hp 1,5 oilless
- Double start switch
- Capacity filler Bag in Box, Pouch, Cheertainer since 1 liter up to 30 liter
- Semiautomatic hand-wheel for adjust the filling head's height
- Pincer tool for open and close taps. VITOP standard (other on demand)
- Stainless steel desk with 4 wheel
- Adjustable support for cartoon
- S/s fitting for cleaning circuit (CIP). Automatic program for cleaning
- Total drain valve install on pump body
- Pipe in rubber
- Fitting connection Triclover 1,5"

MODEL

Cod.	Description	€
9113	Semi-automatic filling BB20 without compressor and without pump	
9019	Semi-automatic filling BB20 without compressor, with pump	
9018	Semi-automatic filling BB20 with pump and silenced compressor	
9011	Semi-automatic filling TOP BB20 inox panel, speed variator, flow meter inox 9106, silenced compressor	

MODEL	FITTING TRICLOVER	CAPACITY 5 lt/h	CAPACITY 10 lt/h	CAPACITY 20 lt/h	POWER HP (Kw)	DIMENSION	WEIGHT
9113/9019/9018 9011	1,5" with hose 20mm	240	180	130	1,1 220V, 50-60hz Single-phase	600x820x1600 mm	140 Kg



Optional for semiautomatic filling BB20



Video



Cod. 9032 - Inox trolley for horizontal transport



Cod. 9029 - Housing filter 30" in INOX



Cod. 9110 - temperature control and Cod. 9048



Cod. 9112 - Stainless steel panel control



Cod. 9031 - Kit for filling LOWER POUCH bags



Cod. 9405 - Kit for filling bags in drums 220 Lt

OPTIONAL		
Cod.	Description	€
9106	Difference for induction flowmeter inox, for steam sanitation 120C° and viscous liquid (0.2% accuracy in repeatability) with no drop system	
9111	Kit OLIVE OIL filling, composed of a stainless steel flow meter, pipe in rubber, special filling head no-drop system.	
9112	Stainless steel panel control	
9017	Electronic speed variator kw 1,5 single-phase	
9013	Housing filter 10" in PVC for security sterilization (membrane excluded)	
9029-20	Housing filter 30" in INOX, (membrane excluded), installed on board	
9405	Kit for filling bags in drum 220 Lt	
9103	Additional stainless steel fitting for CIP circuit (one unit is included in the machine cost)	
9032	Inox trolley back side, for horizontal transport	
9046	Additional kit to fill different type of taps	
9031	Kit for filling LOWER POUCH bags (in addition to the standard tool)	
9119	Difference for volumetric pump capacity 9300lt/h with bypass and total drain valve (our model Euro40)	
9039	2000 lt/h lobe pump (requires code 9106 and code 9017)	
9110	Automatic temperature control with liquid return circuit	
9151	Buffer tank 45 liter, with 2 level sensor for connection with a pasteurizer	
9345	Three-way pneumatic solenoid valve for code 9151 included electronic floating switch singlephase.	
9348	Bottle filling kit of 0,5 and 1 lt, only with cod.9017	
9105	Stainless steel double step nitrogen pressure reducer	



AUTOMATIC FILLING BB30 for Bag in Box



Video



MODEL		
Cod.	Description	€
9400	Automatic filling BB30 - with pump capacity 4500 lt/h	
9401	Automatic filling BB30 - with pump capacity 9300 lt/h	
OPTIONAL		
Cod.	Description	€
9333	Electronic speed variator kw 1,5 single-phase	
9108	Difference for induction flowmeter inox, for steam sanitification 120°C and viscous liquid (0.2% accuracy in repeatability)	
9171	Kit for olive oil consisting of a turbine stainless steel sensor	
9013	Housing filter 10" in PVC (membrane excluded)	
9029-30	Housing filter 30" in INOX on separated 9029 support (membrane P7 excluded)	
9121	Air compressor silenced oilless type professional on trolley	
9039	2000 lt/h lobe pump (requires code 9333 and code 9108)	
9122	Air filter with 3 step filtration	
9170	Pneumatic head for special caps	
9125	Industry 4.0 ready with remote control	
9185-30	Ultraclean system for sanitizing at the beginning and end of the cycle	
9151-30	Buffer tank 45 liter, with 2 level sensor for connection with a pasteurizer	
9345	Three-way pneumatic solenoid valve for code 9151 included electronic floating switch singlephase.	

STANDARD FEATURES

- Panel control in inox with touch screen PLC SIEMENS touch-sceen 7" multilanguage and multiprogram
- Electromagnetic flow meter Burkert type
- Vacuum system
- Nitrogen injection
- Automatic open/close of the bags. Vitop standard supplied
- Volumetric pump with rubber impeller self priming 900 rpm, with bypass and total drain valve
- Vacuum-sealed filling system
- Possibility to fill flexible bags or Pouch (higher type) since 1Lt capacity
- Frame in stainless steel with 4 wheels
- Inox fitting for CIP cleaning. Automatic cleaning program
- 220V single-phase power supply
- Safety protection
- Adjustable inox support for cartoon

MODEL	CONNECTION	CAPACITY 3 lt/h Pz	CAPACITY 5 lt/h Pz	CAPACITY 10 lt/h Pz	CAPACITY 20 lt/h Pz	POWER Hp (Kw)	DIMENSION mm	WEIGHT
9400	TRICLOVER 1,5"	380	240	210	140	1,5 (1,1)	800x1000x1500	140 Kg
9401	TRICLOVER 1,5"	450	300	240	180	2 (1,5)	800x1000x1500	144 Kg



AUTOMATIC FILLING BB40 for Bag in Box



Video



STANDARD FEATURES

- Siemens PLC
- Multilingual program
- Induction flowmeter in stainless steel
- Program for single bag or continuous bag
- Cycle with vacuum and nitrogen injection
- Vacuum filling system
- Extension for continuous filling of 10-20 l bags (OPTIONAL)
- Additional stainless steel roller conveyor for continuous filling of 10-20 liter bags (OPTIONAL)
- Standard VITOP tap adjustment
- Speed variator for pump
- Cardboard support
- Automatic cleaning program
- ready for hot filling and steam sanification 120 °C
- POWER 220V Single-phase / 380V 5 poles Three-phase
- Volumetric pump EURO 40 with rubber impeller, bypass and total drain valve

MODEL

Cod.	Description	€
9440	Automatic filler BB40 with pump 9300 lt/h	

OPTIONAL

Cod.	Description	€
9134	Additional stainless steel roller conveyor on wheels for continuous filling of 10 and 20 liter bags	
9029-40	Housing filter 30" in INOX on separated support (membrane P7 excluded)	
9121	Air compressor silenced oilless type professional on trolley	
9122	Air filter with 3 step filtration	
9125	Ready for industry 4.0 with remote control	
9185-40	Ultraclean system for sanitizing at the beginning and end of the cycle	
9039	Difference for 2000 l / h lobe pump	

MODEL	FITTING	POWER	CAPACITY 5 lt/h Pz	CAPACITY 10 lt/h Pz	CAPACITY 20 lt/h Pz	ENGINE Hp (Kw)	DIMENSION mm	WEIGHT
9440	DIN 40	Single-phase 220V 50Hz Three-phase 380V 5 Poles	450	300	200	2 (1,5)	800x1600x1800	170 Kg



AUTOMATIC FILLING AND PACKAGING BB50 for Bag in Box



Video

Manual roller conveyor for packaging

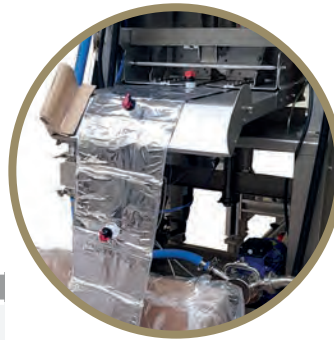

Automatic drag bags

Automatic separation bags

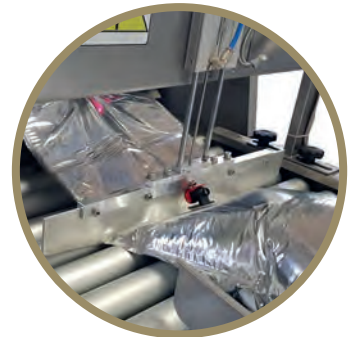

STANDARD FEATURES

- Siemens PLC
- Remote assistance kit with LAN connection
- Control panel installed on stainless steel support on wheels with 5 meter cable connection
- Electronic panel with 7 "multilingual touch screen PLC and multiprogram
- Automatic separation of bags
- Self-priming electric pump with rubber impeller, flow rate 9300 lt/h, 900 rpm, total drain valve
- Vacuum filling system
- Continuous filling of bags with VITOP tap (other taps on demand)
- Structure in stainless steel
- Electronic speed variator for pump
- Fitting connection for the CIP circuit
- Filling 3-5-10-20 lt
- Special conical hopper for 3 carton size
- Manual roller conveyor for cardboard insertion
- Power 380V 5 Poles

MODEL

Cod.	Description	€
9450	Automatic filling BB50 with pump, bags separation, bags input inside the carton.	

OPTIONAL

Cod.	Description	€
9125	Ready for industry 4.0 with remote control	

MODEL	FITTING	POWER	CAPACITY 3 lt/h Pz	CAPACITY 5 lt/h Pz	CAPACITY 10 lt/h Pz	CAPACITY 20 lt/h Pz	ENGINE Hp (Kw)	DIMENSION mm	WEIGHT
9450	triclover da 1,5"	Three-phase 5 poli 380V 50hz	500	480	280	200	2,5 Kw	3300x1100x2500	650 Kg



Optional for filling machines BB40 e BB50



Cod. 9128 - Manual roller conveyor



Cod. 9135 - Motorized roller conveyor

Cod. 9129 - Isobaric tank



Cod. 9123 - Atmospheric tank



OPTIONAL		
Cod.	Description	€
9132	Difference for DN 25 gear flowmeters in stainless steel for filtered dense viscous liquids	
9133	Difference for mass flowmeter in stainless steel DN 25	
9123	Atmospheric storage tank in stainless steel of 200 liters, with 3 level probes, control panel threephase for external pump, nitrogen saturation, valve pneumatic closing (for filtration system connection before filling)	
9129	Difference, for 9450 filler, 100 Lt automatic isobaric tank with PLC control unit (in alternative to the volumetric pump and the speed variator)	
9137	Difference for Isobaric tank for cod. 9440	
9128	Manual roller conveyor in stainless steel, length 2500 mm with adjustable sides for driving bags and / or boxes	
9135	Difference for automatic roller conveyor 2500 mm motorized, to be added to code 9450 (alternative to the standard manual conveyor)	
9136	Insulated tank 300 Lt with ultrasonic probes and input two-way valve	
9130	Tipper for bags of 3 and 5 Lt for cod. 9450	
9138	Control station of weight with idle roller conveyor for discharge	



COMPLETE BAG IN BOX PACKING LINE

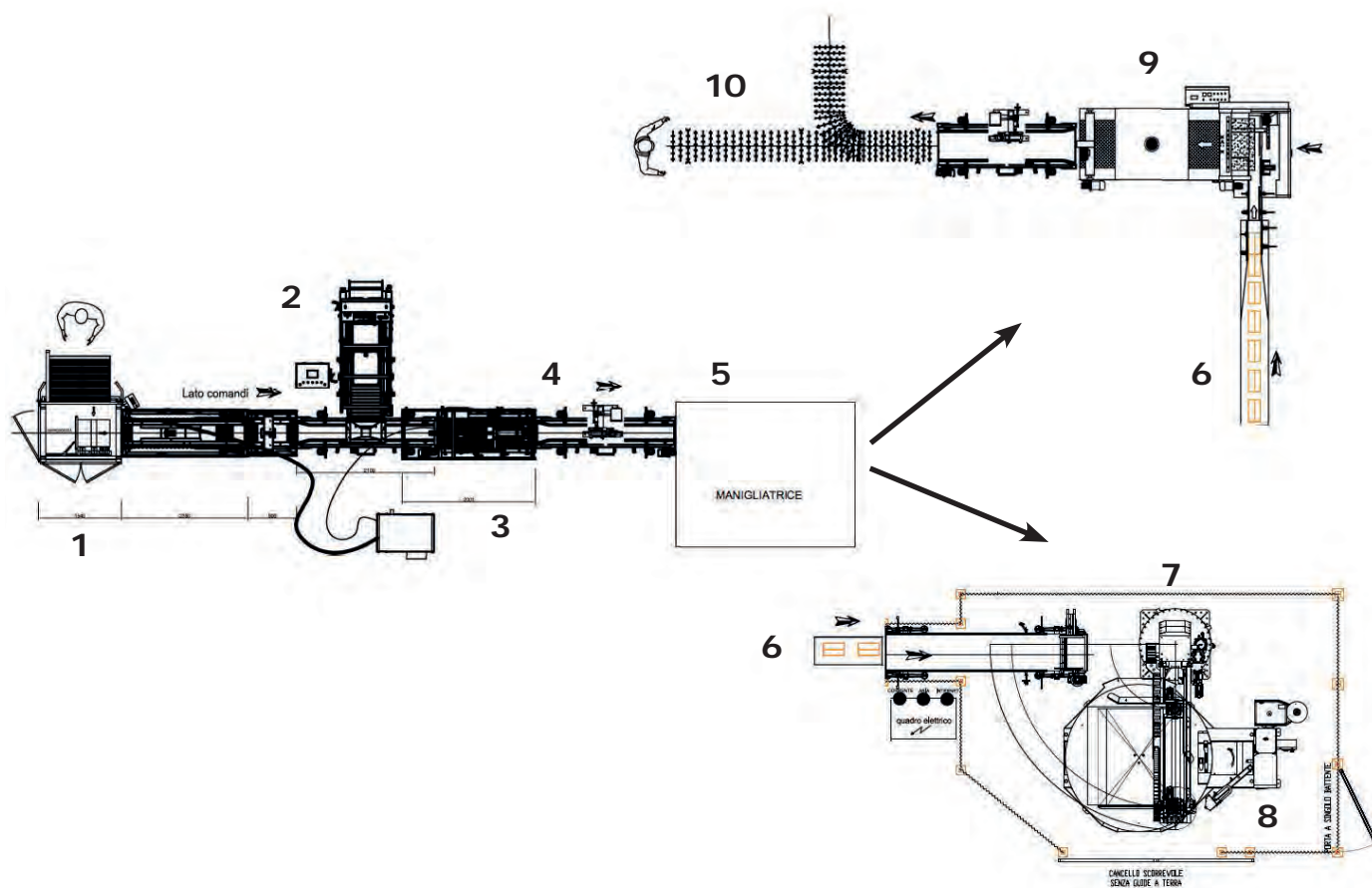

STANDARD FEATURES

- Capacity 600 pz/h for 3 lt bags
- QUOTATION ON DEMAND

OPTIONAL

Cod.	Description	€
1	CARTON FORMER	
2	FILLER	
3	CARTON CLOSER	
4	WEIGHT	
5	HANDLE	

OPTIONAL

Cod.	Description	€
6	LABEL	
7	PALLETIZER	
8	WRAPPER	
9	BUNDLER	
10	MANUAL BELT	



COMBINED FILLER *for hot liquids*



STANDARD FEATURES

- EURO 30 pump with EPDM impeller
- Induction flowmeter in stainless steel
- Silenced compressor
- No-drop filling valve
- Electronic level sensor (no panel control)
- Inlet DN32
- N.4 filling heads 15mm
- Bimetallic thermometer

MODEL

Cod.	Description	€
9500	Combined filler: bag in box filler BB20 + gravity filler desk type with 4 filling heads	

OPTIONAL

Cod.	Description	€
9110	Automatic temperature control with bypass circuit for bag in box	
9017	Electronic speed variator for Bag in Box pump	
9112	Panel control in stainless steel	
9345	Three-way pneumatic solenoid valve for code 9151 included electronic floating switch singlephase	
9311	Electronic floating with predisposition for connection to external single phase pump	

MODEL	FITTING	CAPACITY 5 lt/h	CAPACITY 10 lt/h	CAPACITY 20 lt/h	CAPACITY BOTTLE.	POWER (Kw)	DIMENSION	WEIGHT
9500	DIN25	240	180	130	670 lt/h	1,1, 220V, 50-60 hz Single-phase	1060x1100x1950 mm	160 Kg



SCALE FILLING FLUIDA MVE

for viscous liquids (oil) and with suspended solids



Video



9037

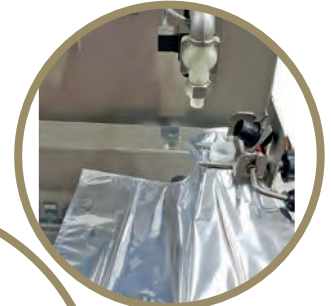

9052



LOBE PUMP with tank of accumulation

STANDARD FEATURES

- Stainless steel frame with 4 wheels
- Scale weighter in stainless steel, maximum 10 kg (30 kg on demand)
- Volumetric pump with rubber impeller HP 1,5, by-pass, capacity 4500 lt/h / alternative HP 0,5 capacity 600 lt
- HP3 stainless steel lobe pump, flow rate 2000 l / h (for code 9600)
- Frequency inverter for pump speed
- PLC panel with 99 memory, including 10 default for main use size
- Automatic tare
- Adjustable filling head with handwheel
- LENTO function, and Manual filling (drops filling)
- Minimum capacity 100 ml
- n°2 different size of filling head
- No-drop pneumatic head for cod.9006 (min pression 6 BAR)

MODEL

Cod.	Description	€
9004	Fluida MVE - with electronic speed variator and pump HP 1,5 (see all the standard feature included in this model)	
9003	Fluida MVE - with electronic speed variator, and pump HP 0,5 (see all the standard feature included in this model)	
9006	Fluida MVE for filling thick liquids (soap, chocolate, honey) or solid (tomatoe sauce). Included lobe pump 2000 l / h (tank of storage optional)	

OPTIONAL

Cod.	Description	€
9053	Centring device for bottles	
9037	Manual valve for nitrogen injection	
9028	Approval load cell at metric office (for Italian market)	
9150	Silenced oilless compressor	
9052	Kit for filling manually bag in box, including tool for open and close faucet (VITOP as standard). max capacity 5 liter bags	

MODEL	CONTAINER PRODUCTION 5 lt/h	CAPACITY	ENGINE (Kw)	DIMENSION	WEIGHT
9004	230	0,1-5 lt	1,1	600x600x1600 mm	110 kg
9003	80	0,1-5 lt	0,37	600x600x1600 mm	108 kg
9006	230	0,1-5 lt	2,2	600x600x1500 mm	138 kg



AUTOMATIC DOSING SYSTEM OPTIMA

high precision, small doses - dosypack



Video



STANDARD FEATURES

- Stainless steel structure with 4 wheels
- PLC system with self-learning system
- N.10 preset memories for volume filling
- Touch-screen display
- Self-priming stainless steel pump with magnetic drive gears
- Electronic speed variator with SLOW function
- Automatic / manual fill selector
- Pedal ignition control
- Filling plane height adjustment
- Accuracy + 1 gr

MODEL

Cod.	Description	€
9020	Filler OPTIMA for filling rigid containers	

OPTIONAL

Cod.	Description	€
9127	Filling kit for sauces, jams, sauces consisting of a lobe pump with a capacity of 800 lt/h, installed on a trolley	
9131	Kit for filling and capping DOSYPACK containers	
9150	Silenced oilless compressor	

MODEL	CAPACITY CANS 1 lt/h	CAPACITY ml	ENGINE (Kw)	DIMENSION	WEIGHT
9020	380	5 - 1000	1,2 Single-phase	600x600x1600 mm	110 Kg



ACCESSORIES TO TRANSFER LIQUID

ACCESSORIES TO TRANSFER LIQUID		
Cod.	Description	€
 7103	<p>Digital flow meter ENO 24 with fitting 1"- certified for alimentary use. For wine, beer, no viscous juice. Max temperature 85 C°</p> <ul style="list-style-type: none"> - Power by battery included - Calibration - Maximum capacity 7000 l/h, 16 bar - Special fitting garolla/DIN/Clamp 	
 7107	<p>DIGITAL FLOW METER ENO 400 with hose connector Ø 20 mm - certified for alimentary use. Oil and liquids dense and semi-dense.</p> <ul style="list-style-type: none"> - Power by battery included - Calibration - Maximum capacity 1600 l/h, 16 bar 	
 7106	<p>STAINLESS STEEL FILLING GUN, with automatic system and shockproof rubber gasket. Hose connector Ø 20 mm.</p>	
 7102	<p>STAINLESS STEEL FILLING GUN, with automatic system and shockproof rubber gasket. Swivel fitting for ENO 24 flow meter connection.</p>	
 7111	<p>STAINLESS STEEL FILLING GUN for filling top barrels</p>	
 7112	<p>STAINLESS STEEL FILLING GUN for barrique application with connection DIN 25 and adjustable terminal</p>	



ACCESSORIES TO TRANSFER LIQUID

ACCESSORIES TO TRANSFER LIQUID		
Cod.	Description	€
 7110-20 7110-25 7110-30	PLASTIC FILTER, with hose connector Ø 20/25/32 mm	
 7125	RUBBER PIPE for food liquids (wine, oil, juices,...) Ø 20 mm	
 7126	PLASTIC PIPE with Inox spring inside Ø 20 mm	
 7131	MANUAL CORKING MACHINE ITALIA WITH NYLON INSERT, FOR CORKS AND SILICON TAP	
 7132	MINI ITALIA CLOSE MACHINE	
 7134	MANUAL CLOSING SYSTEM FOR SCREW TAP Ø 22-24 mm Height 15-24 mm	



**EASY LINE
GRAPE PROCESSING**



CRUSHER MICROENO, MINIENO, ENO 1 e ENO 2



ENO 1, ENO 2 - Stainless steel hopper, with engine

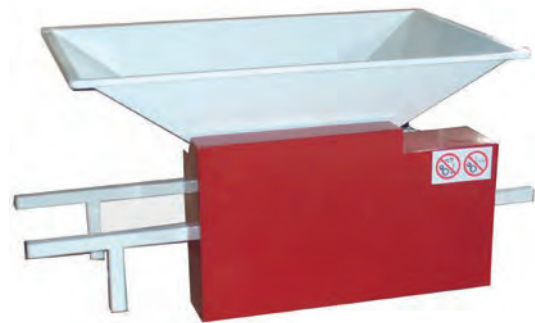

ENO 1, ENO 2 - smalted with engine



MICROENO, MINIENO, ENO 1, ENO 2 - inox hopper with flywheel



Safety protection

MODEL		
Cod.	Description	€
494	MICROENO - smalted hopper	
491	MINIENO - smalted hopper and agitator	
492	MINIENO - hopper and agitator Inox	
501	ENO 1 - smalted hopper and agitator	
502	ENO 1 - hopper and agitator Inox	
503	ENO 1 - with ENGINE, smalted hopper and agitator	
504	ENO 1 - with ENGINE, hopper and agitator Inox	
511	ENO 2 - smalted hopper and agitator	
512	ENO 2 - hopper and agitator Inox	
513	ENO 2 - with ENGINE, smalted hopper and agitator	
514	ENO 2 - with ENGINE, hopper and agitator Inox	

STANDARD FEATURES
<ul style="list-style-type: none"> • Autoadjustable food aluminium rollers • CE motor with emergency stop • Cartoon box packaging • Steel protective casing

OPTIONAL		
Cod.	Description	€
006	Safety protection (required to issue a conformity declaration)	

MODEL	ENGINE HP (Kw)	HOURLY PRODUCTION	HOPPER	DIMENSION mm		WEIGHT		ROLLER LENGHT
				with flywheel	with engine	with flywheel	with engine	
MICROENO	---	200 - 450 Kg/h	555x455 mm	860x365x470	---	14 Kg	---	150 mm
MINIENO	---	300 - 500 Kg/h	650x470 mm	1000x390x490	---	18 Kg	---	220 mm
ENO 1	1 (0,75)	500 - 700 Kg/h	850x560 mm	1210x580x350	1210x500x570	22 Kg	33 Kg	220 mm
ENO 2	1 (0,75)	600 - 800 Kg/h	1000x630 mm	1210x620x400	1210x550x620	29 Kg	40 Kg	280 mm



CRUSHER DESTEMMER ENO 3

ENO 3 INOX - with ENGINE, hopper and agitator Inox



ENO 3 - with flywheel smalted hopper and agitator

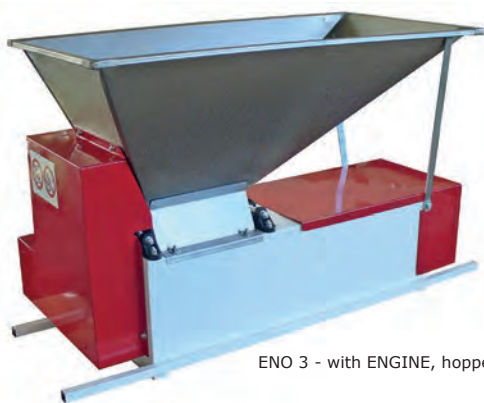

ENO 3 - with ENGINE, hopper Inox



Safety protection

MODEL		
Cod.	Description	€
521	ENO 3 - smalted hopper and agitator	
522	ENO 3 - hopper and agitator Inox	
525	ENO 3 INOX - hopper and agitator Inox	
523	ENO 3 - with ENGINE, smalted hopper and agitator	
524	ENO 3 - with ENGINE, hopper and agitator Inox	
526	ENO 3 INOX - with ENGINE, hopper and agitator Inox	

OPTIONAL		
Cod.	Description	€
009	Inox stand with slide	
006	Safety protection (required to issue a conformity declaration)	

STANDARD FEATURES

- Autoadjustable food aluminium rollers
- CE motor with emergency stop
- Stainless steel basket
- Cartoon box packaging
- Steel protective casing

MODEL	ENGINE HP (Kw)	HOURLY PRODUCTION	HOPPER	DIMENSION mm		WEIGHT		ROLLER LENGHT
				with flywheel	with engine	with flywheel	with engine	
ENO 3	1 (0,75)	1000 - 1200 Kg/h	850x500 mm	1210x550x690	1210x600x690	40 Kg	51 Kg	220 mm
STAND	---	---	---	1100x500x250	1210x500x620	8 Kg	---	---



DESTEMMER ENO 10



ENO 10 - with engine, inox



ENO 10 - with engine, smalted



Inox stand with slide



Safety protection

STANDARD FEATURES

- CE motor with emergency stop
- Carton box packaging
- Steel safety protection
- steel protective casing

MODEL

Cod.	Description	€
012	ENO 10 - with ENGINE, smalted	
212	ENO 10 INOX - with ENGINE, Inox	

OPTIONAL

Cod.	Description	€
009	Inox stand with slide	
006	Safety protection (required to issue a conformity declaration) 	

MODEL	ENGINE HP (Kw)	HOURLY PRODUCTION	SPEED	DIMENSION	WEIGHT
ENO 10	1 (0,75)	1000 - 1200 Kg/h	500 RPM	1210x600x690 mm	50 Kg
STAND	---	---	---	1100x550x620 mm	8 Kg



CRUSHER DESTEMMER ENO 15



Video

Cod. 027 - 028

ENO 15 INOX - With engine



Safety protection

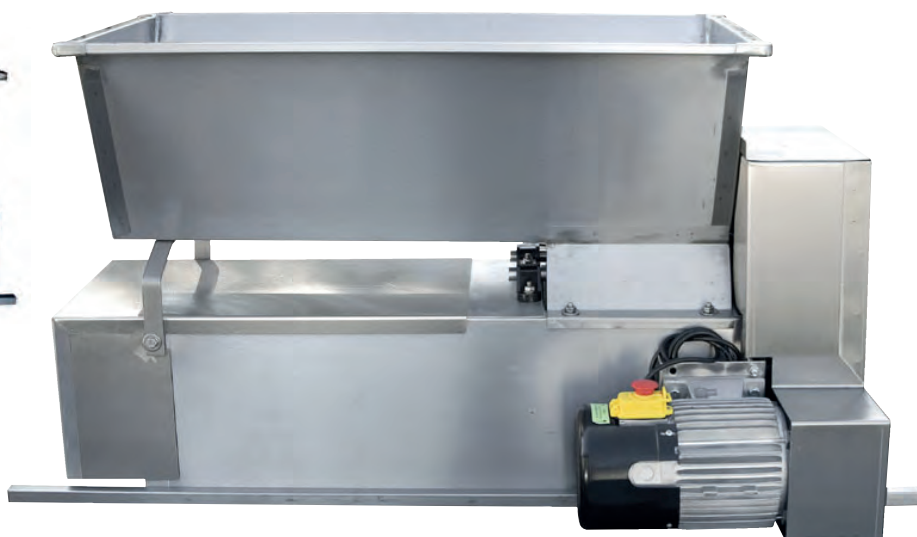

ENO 15 - with engine, smalted

MODEL		
Cod.	Description	€
025	ENO 15 - Aluminium roller, smalted hopper	
024	ENO 15 - Rubber roller, smalted hopper	
027	ENO 15 - Aluminium roller, Inox hopper	
028	ENO 15 - Rubber roller, Inox hopper	
225	ENO 15 INOX - Aluminium roller	
224	ENO 15 INOX - Rubber roller	

OPTIONAL		
Cod.	Description	€
009	Inox stand with slide	
006	Safety protection (required to issue a conformity declaration) 	

STANDARD FEATURES
<ul style="list-style-type: none"> Adjustable aluminium roller for alimentary use HP 1 engine with CE emergency stop Stainless steel basket Cartoon box packing Steel protective casing

MODEL	ENGINE HP (Kw)	HOURLY PRODUCTION	SPEED	DIMENSION HOPPER	DIMENSION	WEIGHT
ENO 15	1 (0,75)	1600 - 1800 Kg/h	500 RPM	850x480	1210x600x630 mm	54 Kg
STAND	---	---	---	---	1100x550x620 mm	8 Kg



CRUSHER DESTEMMER SEMICENTRIFUGAL ENO 20

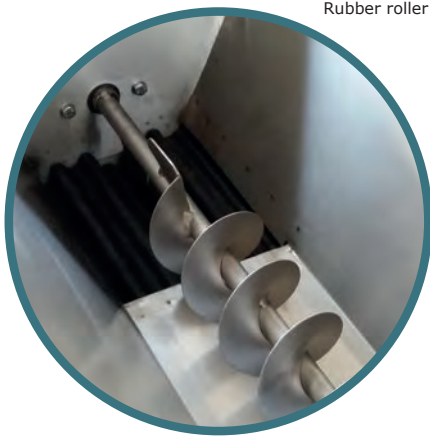

Rubber roller



ENO 20 INOX - with engine, Inox



ENO 20 - with engine, smalted hopper



Safety protection

MODEL		
Cod.	Description	€
482	ENO 20 - Aluminium roller, smalted	
483	ENO 20 - Rubber roller, smalted	
485	ENO 20 INOX - Aluminium roller	
486	ENO 20 INOX - Rubber roller	

OPTIONAL		
Cod.	Description	€
006	Safety guard with internal pyramid grid 	

STANDARD FEATURES

- CE motor with emergency stop
- Stainless steel basket
- Stainless steel centrifuge pump
- Stretch wrap packaging
- Steel protective casing

MODEL	ENGINE HP (Kw)	HOURLY PRODUCTION	SPEED	PUMP	PUMP HEADS	DIMENSION	WEIGHT
ENO 20	2 (1,5)	1500 - 1800 Kg/h	500 RPM	60 Ø	15 Oriz. - 5 Vert.	1120x600x960 mm	70 Kg



DESTEMMER CRUSHER SEMICENTRIFUGE ARNO 15, 25, 35



ARNO INOX - with engine



ARNO - with engine, smalted



Safety protection



Opening system

MODEL		
Cod.	Description	€
033	ARNO 15 - smalted	
233	ARNO 15 INOX	
042	ARNO 25 - smalted	
242	ARNO 25 INOX	
052	ARNO 35 - smalted	
252	ARNO 35 INOX	

STANDARD FEATURES

- CE motor with emergency stop
- Stainless steel basket
- Stainless steel centrifuge pump
- Stretch wrap packaging
- Steel protective casing

OPTIONAL

Cod.	Description	€
006	Safety guard with internal pyramid grid 	

MODEL	ENGINE HP (Kw)	HOURLY PRODUCTION	SPEED	PUMP	PUMP HEADS	DIMENSION	WEIGHT
ARNO 15	2 (1,5)	2000 Kg/h	500 RPM	60/50 Ø	15 Oriz. - 5 Vert.	1100x700x900 mm	78 Kg
ARNO 25	2,5 (1,8)	3000 Kg/h	500 RPM	60 Ø	15 Oriz. - 5 Vert.	1200x700x900 mm	86 Kg
ARNO 35	2,5 (1,8)	3800 Kg/h	500 RPM	60 Ø	15 Oriz. - 5 Vert.	1300x700x900 mm	100 Kg



DESTEMMER CRUSHER SEMICENTRIFUGE JOLLY 15/E, 25/E, 35/E



JOLLY Inox - with engine

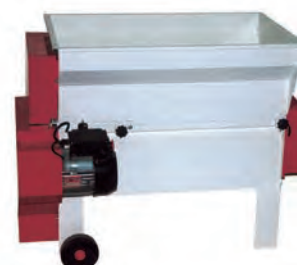

JOLLY - with engine, smalted



Safety protection



Opening system

STANDARD FEATURES

- CE motor with emergency stop
- Stainless steel basket
- Stainless steel centrifuge pump
- Stretch wrap packaging
- steel protective casing

MODEL

Cod.	Description	€
063	JOLLY 15/E - smalted	
263	JOLLY 15/E INOX	
082	JOLLY 25/E - smalted	
282	JOLLY 25/E INOX	
092	JOLLY 35/E - smalted	
292	JOLLY 35/E INOX	

OPTIONAL

Cod.	Description	€
006	Safety guard with internal pyramid grid	



MODEL	ENGINE HP (Kw)	HOURLY PRODUCTION	SPEED	PUMP	PUMP HEADS	DIMENSION	WEIGHT
JOLLY 15/E	2 (1,5)	2000 Kg/h	500 RPM	60/50 Ø	15 Oriz. - 5 Vert.	1130x680x900 mm	80 Kg
JOLLY 25/E	2,5 (1,8)	3000 Kg/h	500 RPM	60 Ø	15 Oriz. - 5 Vert.	1230x680x900 mm	94 Kg
JOLLY 35/E	2,5 (1,8)	3800 Kg/h	500 RPM	60 Ø	15 Oriz. - 5 Vert.	1330x680x900 mm	110 Kg



**PROFESSIONAL LINE
GRAPE PROCESSING**



DESTEMMER CRUSHER SEMICENTRIFUGE JOLLY AR



Video



Jolly AR INOX with engine



Opening system

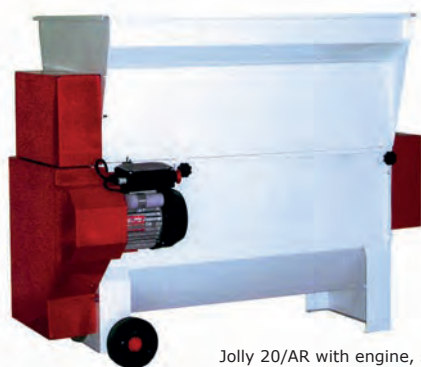
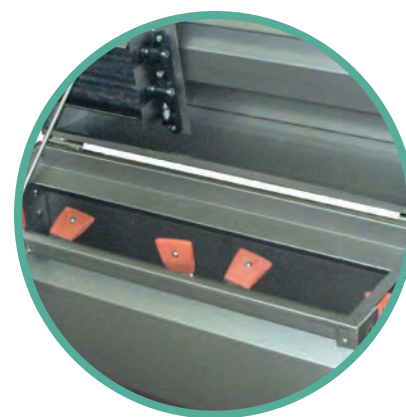

Jolly 20/AR with engine, smalted

STANDARD FEATURES

- Autoadjustable rubber food rollers
- Destemmer shaft with rubber tips
- CE motor with emergency stop
- Stainless steel basket
- Stainless steel centrifuge pump
- Stretch wrap packaging
- Steel protective casing

MODEL		
Cod.	Description	€
102	JOLLY 20/AR - smalted with safety protection	
302	JOLLY 20/AR INOX - with safety protection	
312	JOLLY 30/AR INOX - with safety protection	

OPTIONAL		
Cod.	Description	€
006	Safety guard with internal piramid grid, in addition to the standard	
007	Difference for stainless steel screw with food-grade rubber coating (only for codes 302 and 312)	

MODEL	ENGINE HP (Kw)	HOURLY PRODUCTION	SPEED	PUMP	PUMP HEADS	DIMENSION	WEIGHT
JOLLY 20/AR	2 (1,5)	2000-2300 Kg/h	500 RPM	60 Ø	15 Oriz. - 5 Vert.	1180x680x900 mm	112 Kg
JOLLY 30/AR	2,5 (1,8)	3000-3300 Kg/h	500 RPM	60 Ø	15 Oriz. - 5 Vert.	1280x680x900 mm	128 Kg



DESTEMMER CRUSHER CENTRIFUGE JOLLY 50/A



JOLLY 50/A - INOX with engine



Opening system



JOLLY 50/A- with engine, smalted

STANDARD FEATURES

- Stainless steel centrifugal basket
- Destemmer shaft with rubber blades
- CE motor with emergency stop
- Stainless steel centrifuge pump
- Stretch wrap packaging
- steel protective casing

MODEL

Cod.	Description	€
122	JOLLY 50/A - smalted, complete with safety protection	
322	JOLLY 50/A INOX complete with safety protection	

OPTIONAL

Cod.	Description	€
006	Safety guard with internal piramid grid (in addition to the standard supplied)	
007	Difference for stainless steel screw with food-grade rubber coating	

MODEL	ENGINE HP (Kw)	HOURLY PRODUCTION	SPEED	PUMP	PUMP HEADS	Ø BASKET	DIMENSION	WEIGHT
JOLLY 50/A	3 (2,2)	4500-5500 Kg/h	500 RPM	60 Ø	18 Oriz. - 5 Vert.	300 mm	1500x800x970 mm	130 Kg



DESTEMMER CRUSHER CENTRIFUGE BETA



Beta INOX with engine special voltage

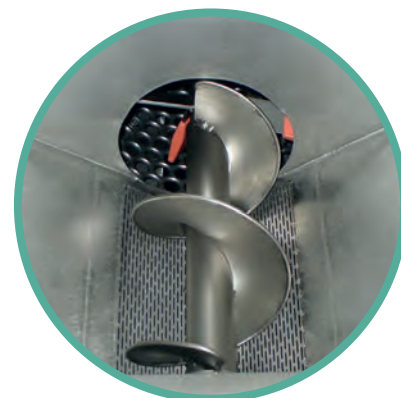

HOPPER Beta with filter



Opening system



MODEL		
Cod.	Description	€
332	BETA 60 INOX with safety protection	
342	BETA 90 INOX with safety protection	
352	BETA 120 INOX with safety protection	

OPTIONAL		
Cod.	Description	€
006	Safety guard with internal pyramid grid (in addition to the standard supplied)	
353	Inox flange with conical fitting 80-60 garolla type instead of centrifuge pump	

STANDARD FEATURES

- Stainless steel centrifugal basket
- Destemmer shaft with rubber tips
- CE motor with emergency stop
- Stainless steel centrifuge pump
- Stretch wrap packaging
- Steel protective casing

MODEL	ENGINE HP (Kw)	HOURLY PRODUCTION	SPEED	PUMP	PUMP HEADS	Ø BASKET	DIMENSION	WEIGHT
BETA 60	3 (2,2)	5000-6000 Kg/h	500 RPM	60 Ø	18 Oriz. - 5 Vert.	300 mm	1650x1050x1100 mm	160 Kg
BETA 90	4 (3)	8000-10000 Kg/h	500 RPM	60 Ø	20 Oriz. - 6 Vert.	400 mm	1950x1100x1100 mm	200 Kg
BETA 120	5,5 (4)	10000-12000 Kg/h	500 RPM	60 Ø	20 Oriz. - 6 Vert.	500 mm	2000x1100x1180 mm	230 Kg



DESTEMMER CRUSHER SEMICENTRIFUGE JOLLY 40 MV



Cod. 390 + Cod. 004



Cod. 396 + Cod. 001



Roller conveyor and collection tank

STANDARD FEATURES

- Professional basket no-laceration semicentrifuge type
- Adjustable and removable rubber rollers
- Engine 1,8 KW with emergency stop CE
- Collection tank with central screw, completely removable, double connection DN80
- Destemmer shaft with rubber tips
- N°4 wheels Ø 100 mm
- Safety protection CE

MODEL

Cod.	Description	€
390	JOLLY 40 MV - with crushing unit and collection tank with safety protection included	
396	JOLLY 40 MV - with crushing unit, without collection tank, with higher inox wheels. With safety protection.	

OPTIONAL

Cod.	Description	€
001	Manual speed variator	
004/40	Electronic speed variator	
007	Inox loading screw with rubber profile	
019/40	Additional basket with different hole	

MODEL	ENGINE HP (Kw)	HOURLY PRODUCTION	SHAFT SPEED	ATTACCO PUMP	DIMENSION mm	WEIGHT
JOLLY 40MV	2,5 (1,8) MF 2,5 (1,8) TF	2000-4000 Kg/h	400-600 RPM	80-60 Ø	1390x800x1320 (1370)	160 Kg



DESTEMMER CRUSHER CENTRIFUGE JOLLY 40 REVERSE



Control panel



Cod. 014 collection tank



STANDARD FEATURES

- Centrifuge professional basket, no laceration type
- Adjustable and removable rubber rollers
- Destemmer shaft with rubber tips
- Mechanical speed variator 1,1 KW for destemming unit
- Motor gear reducer 0,75kw for crushing unit
- Central opening
- N.4 wheels
- Safety protection

MODEL

Cod.	Description	€
388	JOLLY 40 Reverse, with crushing unit, electronic variator, safety protection	

OPTIONAL

Cod.	Description	€
014	Collection tank with central screw, double connection DN80, cardan shaft	
019/60	Additional basket with different hole	
3881	Difference for single-phase motorization (panel separate from the machine body)	

MODEL	ENGINE HP (Kw)	HOURLY PRODUCTION	SHAFT SPEED	Ø BASKET	DIMENSION mm	WEIGHT
JOLLY 40	2,5 (1,8) MF/TF	2000-4000 Kg/h	450-600 RPM	250	1800x880x1350	180 Kg



DESTEMMER CRUSHER INOX JOLLY 60 MV



Video

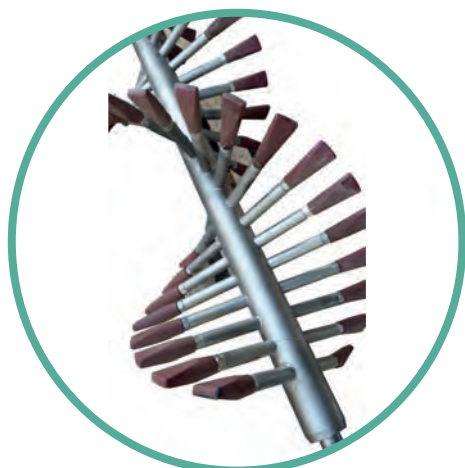

Cod. 003



Opening system

STANDARD FEATURES

- Centrifuge professional basket, no laceration type
- Adjustable and removable rubber roller
- Rubber profile screw welded on the basket
- Electronic speed variator 2,2 Kw
- Destemmer shaft with rubber tips
- Central opening for removing shaft and basket
- Removable control panel with emergency stop
- N°4 wheels Ø 150 mm
- Safety protection CE

MODEL

Cod.	Description	€
391	JOLLY 60 MV - with electronic speed variator, safety protection and crusher unit	

OPTIONAL

Cod.	Description	€
014-60	Collection tank with central screw, double connection DN80, cardan shaft	
003-60	Destemmer shaft with adjustable cylinder	
016-60	Larger hopper for macrobin use	
007	Inox loading screw with rubber profile	
019-60	Additional basket with different hole	

MODEL	ENGINE HP (Kw)	HOURLY PRODUCTION	SHAFT SPEED	Ø BASKET	FITTING PUMP	DIMENSION mm	WEIGHT
JOLLY 60 MV	2,25 (1,6) MF/TF	4000-6000 Kg/h	400-600 RPM	300 mm	60-80	1600x840x1370	180 Kg



DESTEMMER CRUSHER INOX JOLLY 60 MV with integrated sorting line



Video

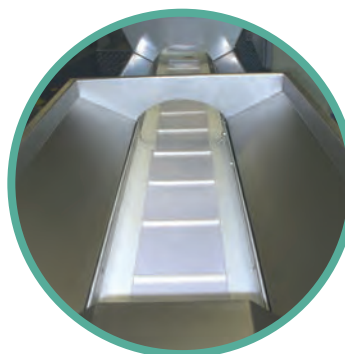
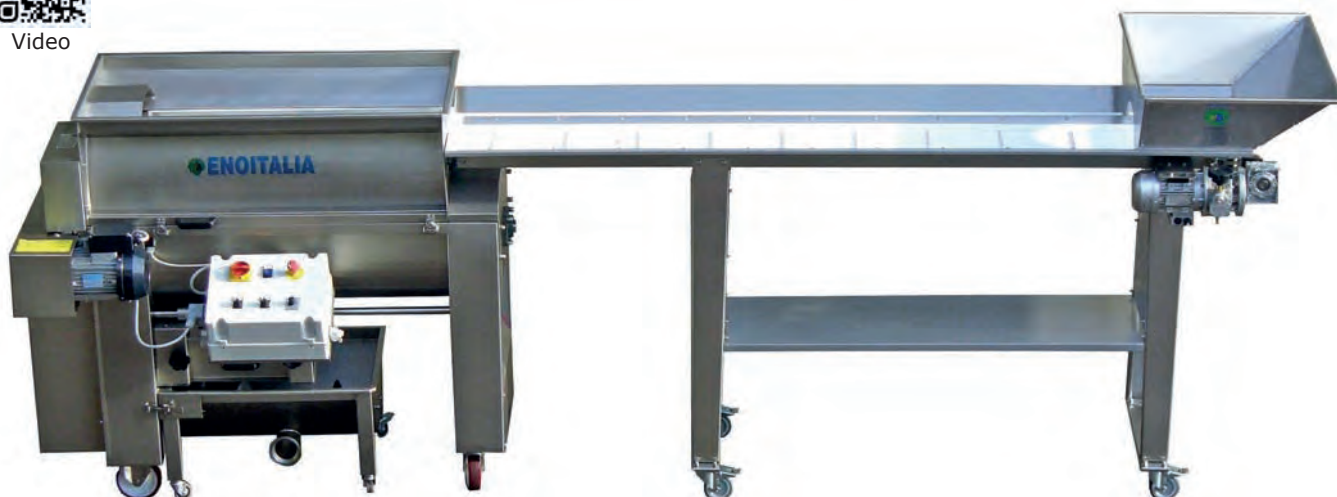

STANDARD FEATURES

- Centrifuge professional basket, no laceration type
- Adjustable and removable rubber rollers
- Rubber profile screw welded on the basket
- Mechanical speed variator 0,5 KW for sorting table
- Electronic speed variator 2,2 KW for destemmer
- Destemmer shaft with rubber plate
- No loading screw
- Removable control panel with emergency stop

MODEL

Cod.	Description	€
391+008	JOLLY 60 MV - with integrated sorting table, crushing unit, speed variator	

OPTIONAL

Cod.	Description	€
014-60	Collection tray with central screw, cardan transmission. Double pump fitting DN 80	
003-60	Difference for destemmer shaft with adjustable cylindrical	

MODEL	ENGINE HP (Kw)	HOURLY PRODUCTION	SPEED	PUMP	LOADING HOPPER	Ø BASKET	DIMENSION	WEIGHT
JOLLY 60 MV	4 (3) TF	4000-6000 Kg/h	400-600 RPM	60-80 Ø	825X650 mm	300 mm	4230x840x1470 mm	300 Kg



DESTEMMER CRUSHER JOLLY 60 RS

Rubber roller

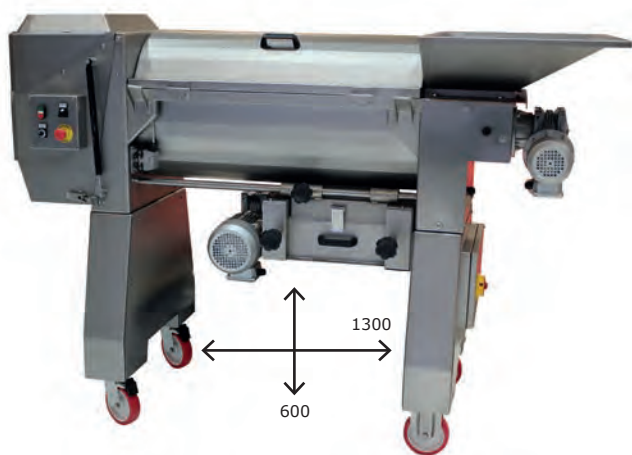
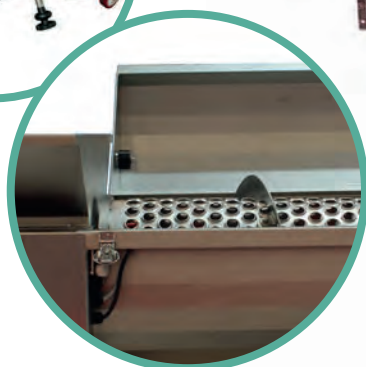

STANDARD FEATURES

- Centrifugal basket in stainless steel, no laceration type
- Adjustable and removable rubber roller, with engine 1,5 Kw
- Loading hopper with motor reducer 0,37 Kw
- Electronic speed variator for destemming unit 1,5 Kw
- Backside opening to remove shaft and basket
- Back cover in stainless steel
- Inox panel control
- Safety protection CE

MODEL

Cod.	Descrizione	€
399	JOLLY 60 RS - with speed variator and crushing unit	

OPTIONAL

Cod.	Descrizione	€
0141	Collection buffer with central screw and engine	
095	Difference for centrifugal basket in polyethylene	

MODEL	ENGINE HP (Kw)	POWER	HOURLY PRODUCTION	SPEED	Ø BASKET	DIMENSION	WEIGHT
399	3,2 Kw	TF 380V-50Hz	4000-7000 Kg/h	350-650 RPM	300 mm	2010x830x1340 mm	180 Kg
		TF 220V-60Hz					



DESTEMMER CRUSHER JOLLY 100 MV



Cod. 392 + 004

Cod. 003



Cod. 0141

MODEL		
Cod.	Description	€
392	JOLLY 100 MV - with gear speed variator and crushing unit	

OPTIONAL		
Cod.	Description	€
0141	Collection hopper with central screw, engine HP 1. Double pump fitting DN 80	
004/100	Difference for electronic speed variator	
003-100	Difference for destemmer shaft with adjustable cylinder tips	
016/100	Extention hopper for macrobin use	

STANDARD FEATURES

- Centrifuge basket, no laceration type
- Adjustable and removable rubber roller
- Rubber profile screw welded on the basket
- Mechanical speed variator 2,2 KW
- Destemmer shaft with rubber tips
- Loading hopper with screw
- Filter for liquid inside the loading hopper
- Central opening for removing shaft and basket
- Control panel with emergency stop CE
- Safety protection CE

MODEL	ENGINE HP (Kw)	HOURLY PRODUCTION	SPEED	Ø BASKET	DIMENSION	WEIGHT
JOLLY 100 MV	3 (2,2)	7000-12000 Kg/h	400-600 RPM	400 mm	2250x1050x1400 mm	280 Kg



DESTEMMER CRUSHER JOLLY REVERSE



Video



Antilaceration basket



Destemmer shaft



Jolly 100 Reverse



Jolly 60 Reverse

STANDARD FEATURES

- Centrifuge basket, no laceration type in stainless steel
- Adjustable and removable rubber roller, with motor Kw 1,5
- Rubber profile screw welded on the basket
- Loading hopper with gear speed variator KW 0,37
- Electronic speed variator for the shaft and the basket
- Destemmer shaft with adjustable rubber tips
- Automatic cleaning system inside the machine (optional for Jolly 60 Reverse)
- Filter for liquid inside the loading hopper DIN 50
- Telescopic legs
- Backside opening for removing shaft and basket
- Back cover in stainless steel
- Inox control panel
- Stainless steel protective casing

MODEL

Cod.	Description	€
389	JOLLY 60 REVERSE with crushing unit	
394	JOLLY 100 REVERSE with crushing unit	
395	JOLLY 180 REVERSE with crushing unit	

OPTIONAL

Cod.	Description	€
0141	Collection with central screw and motor	
016/100	Larger hopper for macrobin use	
9125/R	Industry 4.0 ready with remote control	
096	Washing system for Jolly 60	
095	Difference for centrifugal basket in polyethylene for code 389	
9137	Difference for centrifugal basket in polyethylene for code 394	

MODEL	ENGINE HP (Kw)	HOURLY PRODUCTION	SPEED	Ø BASKET	A (mm)	B (mm)	DIMENSION	WEIGHT
JOLLY 60	4,5 (3,2)	4000-7000 Kg/h	350-650 RPM	300 mm	1300	580-940	2010x830x1340/1740 mm	260 Kg
JOLLY 100	5,5 (4)	7000-12000 Kg/h	350-650 RPM	400 mm	1300	600-960	2600x1050x1530/1930 mm	380 Kg
JOLLY 180	7 (5,5)	15000-19000 Kg/h	350-650 RPM	520 mm	1300	570-970	2880x1220x1550/1950 mm	600 Kg



DESTEMMER CRUSHER JOLLY REVERSE with automatic sorting table



Video

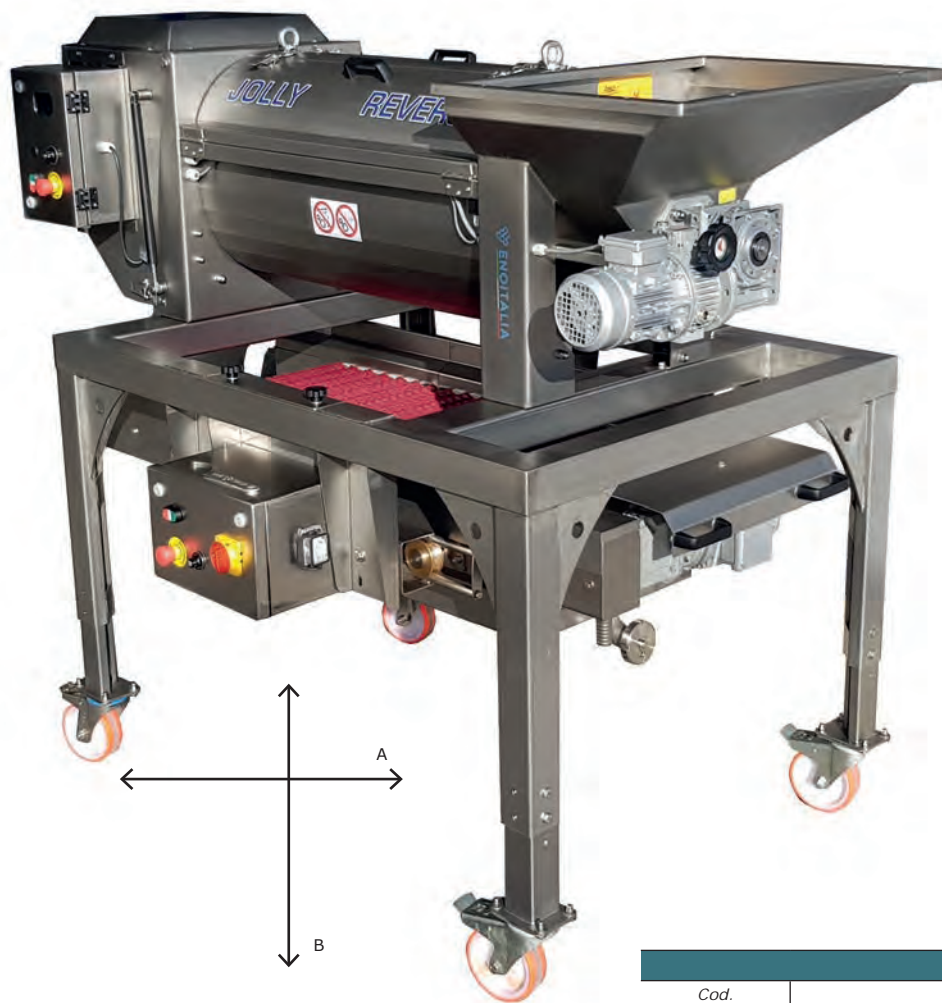

Sorting table



STANDARD FEATURES

- MODEL Jolly 60 Reverse / 100 Reverse destemmer
- Automatic selection roller conveyor
- Roller conveyor install on wheel for adjustable position
- Electronic speed variator for selection roller conveyor
- Removable must collection tank complete with filtration sieve
- Support structure in stainless steel with telescopic legs

MODEL

Cod.	Description	€
820	Jolly Reverse 60 with automatic sorting table	
821	Jolly Reverse 100 with automatic sorting table	

OPTIONAL

Cod.	Description	€
831	Motorized roller unit for installation under the automatic sorting table	

MODEL	ENGINE	PRODUCTION	A (mm)	B (mm)	DIMENSION	WEIGHT
820	4,3 Kw	4000-6000 Kg/h	1267/685	722/972	2050x1100x1950/1700	490 Kg
821	5,4 Kw	7000-10000 Kg/h	1267/685	722/972	2600x1250x2250/1980	610 Kg



DESTEMMER CRUSHER JOLLY REVERSE with vibrating sorting table



Video



Cod. 389+094+095+818+831

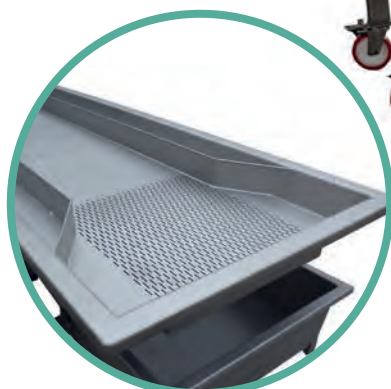

STANDARD FEATURES

- MODEL Jolly 60 Reverse / Jolly 100 Reverse destemmer
- Structure in AISI 304 stainless steel to support the destemmer with telescopic legs
- Vibrating table in stainless steel size 800x3000
- Must collection tank on vibrating table with connection DIN 50
- Electronic speed variator for vibrating table
- CE electrical panel

MODEL

Cod.	Description	€
818	Jolly Reverse 60 with vibrating sorting table	
819	Jolly Reverse 100 with vibrating sorting table	

OPTIONAL

Cod.	Description	€
831	Motorized roller unit for installation under the automatic sorting table	
818	Only vibrating sorting table 3000x800	

MODEL	ENGINE	PRODUCTION	DIMENSION	WEIGHT
818	3,6 Kw	4000-6000 Kg/h	2100x3100x1950 mm	640 Kg
819	4,4 Kw	7000-10000 Kg/h	2600x3100x2250 mm	760 Kg



MOTORIZED CRUSHER

Cod. 830+6201



STANDARD FEATURES

- Frame in stainless steel
- Telescopic legs
- n°2 adjustable rubber rollers
- Height under the roller 520/720 mm
- Loading hopper 1475x725 mm
- Loading height 1065/1265 mm
- Engine HP 1,5 threephase with panel control CE

MODEL

Cod.	Description	€
830	Motorized crusher for whole grape and destemmed grape	

OPTIONAL

Cod.	Description	€
004-RV	Electronic speed variator	

MODEL	ENGINE HP (Kw)	CAPACITY	DIMENSION	WEIGHT
830	1,5 (1,1)	10 Ton / h	1475x835x1590/1390 mm	100 Kg



AUTOMATIC STALKS SHATTER with belt



Loading hopper

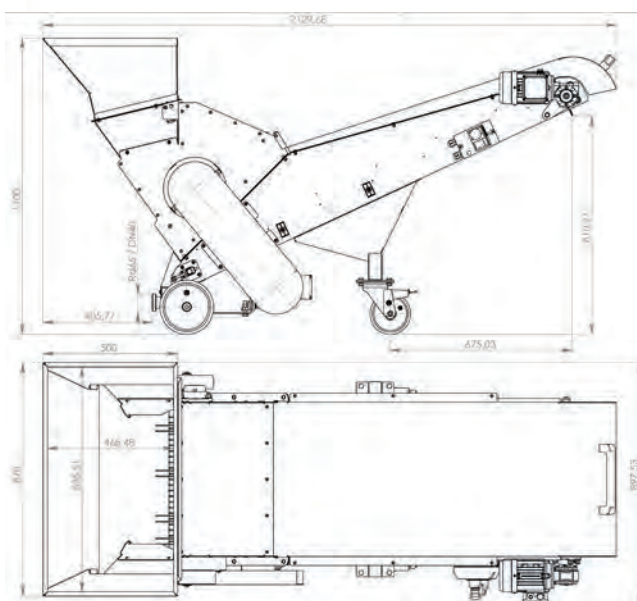

STANDARD FEATURES

- Structure in AISI 304 stainless steel
- Motorized evacuation belt
- Stainless steel crushing knives
- Transport wheels with locking brake
- DIN40 liquid outlet fittings

MODEL

Cod.	Description	€
840	Stainless steel shredder-stalks	

MODEL	POWER	POWER	CAPACITY	DIMENSION	WEIGHT
840	1,68 Kw	Three-phase	10-25 Ton/h	1950x850x1030 mm	150 Kg



SORTING TABLE NC

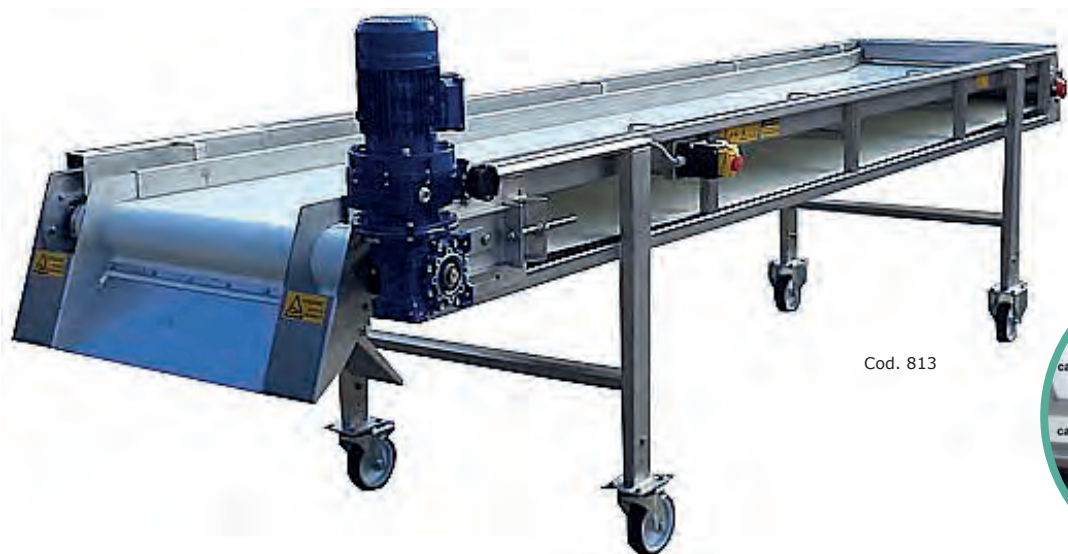

Cod. 813



MODEL		
Cod.	Description	€
810	NC 2500 - 2500x600 mm	
811	NC 2500 - 2500x800 mm	
812	NC 3000 - 3000x600 mm	
813	NC 3000 - 3000x800 mm	
814	NC 3500 - 3500x600 mm	
815	NC 3500 - 3500x800 mm	
816	NC 4000 - 4000x600 mm	
817	NC 4000 - 4000x800 mm	

OPTIONAL		
Cod.	Description	€
004-NC	Electronic speed variator	

STANDARD FEATURES

- Sorting table wide Lenght 600-800 mm
- Frame in stainless steel AISI 304
- Telescopic legs +/- 50 mm
- Gear speed variator kw 0,75 three-phase
- Lateral canal for selected grape
- Hopper for discharging the selected grape
- CE panel control
- N°4 wheel with brake
- Scraper for cleaning

MODEL	INTERNAL WIDE	TABLE HEIGHT	DIMENSION TYPE 2500	DIMENSION TYPE 3000	DIMENSION TYPE 3500	DIMENSION TYPE 4000	CAPACITY
NC 600mm	400	1080-1180 mm	2700x1000x1150 mm 230 Kg	3200x1000x1150 mm 250 Kg	3700x1000x1150 mm 270 Kg	4200x1000x1150 mm 290 Kg	2-10 Ton / h
NC 800mm	600	1080-1180 mm	2700x1200x1150 mm 250 Kg	3200x1200x1150 mm 270 Kg	3700x1200x1150 mm 290 Kg	4200x1200x1150 mm 310 Kg	2-10 Ton / h



SORTING AND LOADING LINE TC

Cod. 429 + Cod. 016

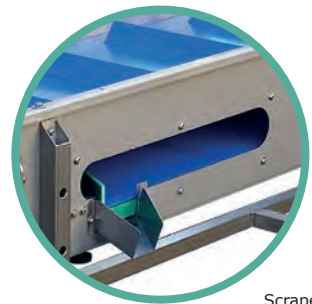
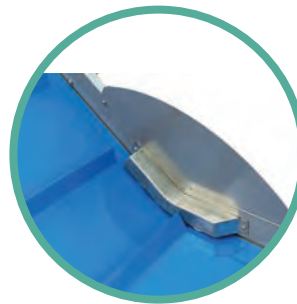

Scraper

STANDARD FEATURES

- Double cover transilon tape, useful width 600 mm profile H. 40 mm, stainless steel coupling hinge
- Structure in AISI 304 stainless steel
- Telescopic legs with 4 stainless steel wheels Ø 100 mm
- Electrical system with emergency stop
- Three-phase motor (single-phase with code 004)
- Mechanical speed variator 1,5 Kw
- Easy cleaning system with inspection doors, liquid scraper and anti-retention structure
- Stainless steel loading hopper

MODEL

Cod.	Description	€
429	TC 4600 - L. 4600 mm	

OPTIONAL

Cod.	Description	€
004/TC	Electronic speed variator three-phase or single-phase	
016/TC	Larger hopper for macrobin use (dimension 1300 x 1100)	

MODEL	ENGINE	LENGHT SORTING TABLE	LENGHT ELEVATOR	HEIGHT TABLE	HEIGHT DISCHARGING	CAPACITY	WEIGHT	DIMENSION
TC 4600	1,5 Kw	3000 mm	1600 mm	800-1050 mm	1870-2000 mm	2-10 Ton/h	230 Kg	4000x800x2500 mm



BELT ELEVATOR SC



Hopper and raise / lower system

STANDARD FEATURES

- Structure in AISI 304 stainless steel
- Double covering food transilon belt width 450 mm with profile H. 50 mm
- Stainless steel loading hopper with recovery tank liquids and side pump connection
- Belt cleaning scraper
- Hydraulic piston for height adjust, from 35 to 50 degree
- 4 wheel for driving
- Mechanical speed variator 1,5 Kw
- 380V 50Hz three-phase motor
- Electrical system with emergency stop

MODEL

Cod.	Description	€
423	SC 3000 - L. 3000 mm, width 450 mm	
424	SC 3500 - L. 3500 mm, width 450 mm	
4241	SC 4000 - L. 4000 mm, width 450 mm	
4242	SC 5000 - L. 5000 mm, width 450 mm	
4243	SC 6000 - L. 6000 mm, width 450 mm	

OPTIONAL

Cod.	Description	€
016/SC	Larger hopper for macrobin use	

MODEL	LENGHT	ENGINE HP (Kw)	HOPPER DIMENSION	LOADING HEIGHT	DISCHARGE HEIGHT	CAPACITY	WEIGHT
SC 3000	3000 mm	2 (1,5)	910x750 mm	710/480 mm	1680/2190 mm	2-10 Ton/h	230 Kg
SC 3500	3500 mm	2 (1,5)	910x750 mm	710/480 mm	1960/2570 mm	2-10 Ton/h	250 Kg
SC 4000	4000 mm	2 (1,5)	910x750 mm	710/480 mm	1800/2600 mm	2-10 Ton/h	320 Kg
SC 5000	5000 mm	2 (1,5)	910x750 mm	710/480 mm	1950/3300 mm	2-10 Ton/h	400 Kg



SCREW ELEVATOR U-200



A mm	B mm
1880	200
1800	330
1520	410
117	550



STANDARD FEATURES

- Screw in inox diameter Ø 200mm lenght 3,00/4,00 mt
- Loading hopper with connection fitting for liquid
- Open cover lid for cleaning
- Winch to adjust the height
- Stainless steel trolley with wheels
- Engine 380V 50Hz three-phase
- CE panel control

MODEL

Cod.	Description	€
421	U-200 - L. 3000 mm	
425	U-200 - L. 4000 mm	

OPTIONAL

Cod.	Description	€
427	Gear speed variator	
016/U	Longer hopper for macrobin use	

MODEL	LENGHT	ENGINE HP (Kw)	HOPPER DIMENSION	LOADING HEIGHT	DISCHARGE HEIGHT	CAPACITY	WEIGHT
U200-3	3000 mm	2 (1,5)	650x720x900 mm	710/480 mm	1600/2000 mm	2-10 Ton/h	90 Kg
U200-4	4000 mm	2 (1,5)	650x720x900 mm	710/480 mm	1900/2500 mm	2-10 Ton/h	130 Kg
TROLLEY	---	---	1330x330x1450 mm	---	---	---	35 Kg



PNEUMATIC PRESS GAMMA

Central loading door



Axial load



STANDARD FEATURES

- Closed cylinder with lateral draining channels
- Sliding and folding door
- Conical bottom collection tank with stainless steel drain valve
- Axial loading DN80 with ball valve
- Electrical panel with PLC touch screen programming with 10 preset and 99 storable programs
- Manual switch to control the press cycle
- Integrated Berker compressor
- Blower for vacuum and inflation Max 0.2 bar
- Wheels for displacement
- Stainless steel protective casing
- Emergency stop with cord and button
- Electrical system with CE safety stop
- Total drain connection DN50 with Gamma 21

MODEL

Cod.	Description	€
6500	GAMMA 5 - single central door	
6501	GAMMA 8 - double door	
6502	GAMMA 11 - double door	
6503	GAMMA 15 - double door	
6504	GAMMA 21 - double door	

OPTIONAL

Cod.	Description	€
431	Level sensor on the collection tank for automatic driven of an external pump	
432	Legs INOX extention 250 mm	
9125-P	Industry 4.0 ready with remote control	

MODEL	CYLINDER CAPACITY	FERMENTED GRAPE CAPACITY	DESTEMMED CAPACITY	WHOLE GRAPE CAPACITY	ENGINE (Kw)	LOADING VALVE	WEIGHT	DIMENSION
GAMMA 5	500 lt	1900 Kg	1400 Kg	400 Kg	3,1	80 DIN	260 Kg	1040x2130x1360 mm
GAMMA 8	800 lt	3040 Kg	2240 Kg	640 Kg	3,5	80 DIN	300 Kg	1040x2410x1460 mm
GAMMA 11	1100 lt	4180 Kg	3080 Kg	880 Kg	3,7	80 DIN	430 Kg	1270x2520x1590 mm
GAMMA 15	1500 lt	5700 Kg	4200 Kg	1200 Kg	4	80 DIN	590 Kg	1270x3020x1590 mm
GAMMA 21	2100 lt	7980 Kg	5880 Kg	1680 Kg	5,6	100 DIN	790 Kg	1600x3180x1860 mm



MANUAL AND AUTOMATIC SVINATORE

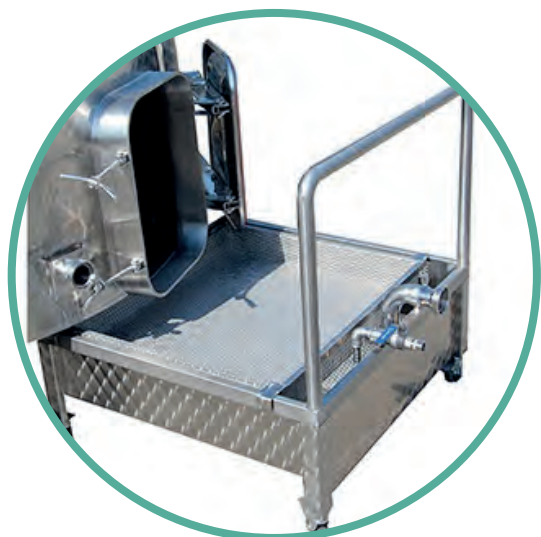

STANDARD FEATURES

- Frame in stainless steel AISI 304
- Extratable filter in stainless steel
- Fitting for connection pump DN 50
- 4 wheels with brakes

MODEL		
Cod.	Description	€
851	Svinatore SV2	
4275	Automatic svinatore with level marker panel control with plug to connect external pump single-phase (pump not included)	
4276	Automatic svinatore with level marker panel control with plug to connect external pump three-phase (PUMP non inclusa)	
4273	Automatic svinatore, with single-phase panel control, and integrated pump ENOS	

MODEL	FITTING	DIMENSION	CAPACITY
SV2	50 garolla	600x700x390 mm	130 lt



AUTOMATIC WASHING TANK



Cod. 997



STANDARD FEATURES

- Frame in stainless steel AISI 304
- Centrifuge pump in stainless steel
- Extractable filter for cleaning
- Connection for total drain
- 4 wheels with brake
- Panel control with emergency stop and termic protection
- Washing head in stainless steel, connection garolla 40 (OPTIONAL)

MODEL

Cod.	Description	€
996	Washing tank - with pump Hp 2 single-phase	
997	Washing tank - with pump Hp 4 three-phase	

OPTIONAL

Cod.	Description	€
993	Stainless steel washing slide complete with anti-scratch profiles and 700mm extension. Terminal sphere d.90	

MODEL	ENGINE HP (Kw)	FITTING	HOPPER DIMENSION	CAPACITY	MAXIMUM HEIGHT TANK'S CYLINDER
996	2 (1,5)	40 garolla	760x1100x370 mm	220 lt	3 mt
997	4 (3)	40 garolla	760x1100x370 mm	220 lt	6 mt



MOTORIZED MIXER



Video

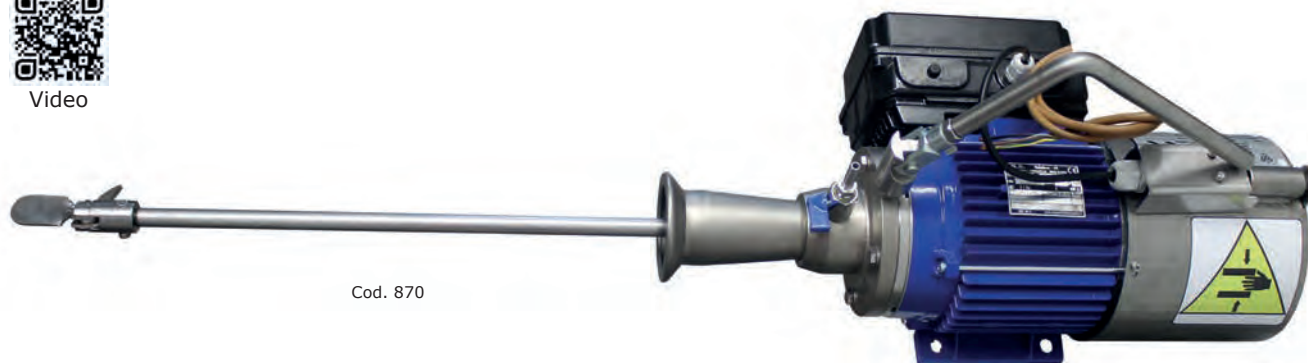

Cod. 870



Cod. 872 + 874



Cod. 872



Cod. 876

STANDARD FEATURES

- Electric motor three-phase, 1,1 Kw/0,8 Kw
- Panel control with emergency stop 24V circuit and transformer (except MIX 90)
- Mechanical seal Grafite/NBR max 12 BAR
- Removable stainless steel shaft length 48 cm.
- Folding helix, automatic opening width 15 cm.
- Inox valve for dosing
- Connection fitting to be indicate at the minimum way 36mm diameter

MODEL

Cod.	Description	€
870	Motorized mixer MIX100	
872	Motorized mixer MIX100 with electronic speed variator Single-phase	
873	Motorized mixer MIX100 with electronic speed variator Three-phase	

OPTIONAL

Cod.	Description	€
876	Inox support with manual regulation (Height center valve 30-140 cm)	
874	Dosing pump EURO 20, HP 1,5 installed on bord with special fitting	
879	Tool to install the mixer on incline valve (only with option 876)	
7023	Mechanical seal	
7056	Timer (requires code 876 for installation)	

MODEL	ENGINE HP (Kw)	POWER	SPEED	TANK max. CAPACITY	DIMENSION	WEIGHT
870	1,5 (1,1)	Three-phase	1400 RPM	300 hl	230x250x960 mm	20 Kg



CARTON FILTER VIRGILIO and MINI VIRGILIO



Mod. VIRGILIO

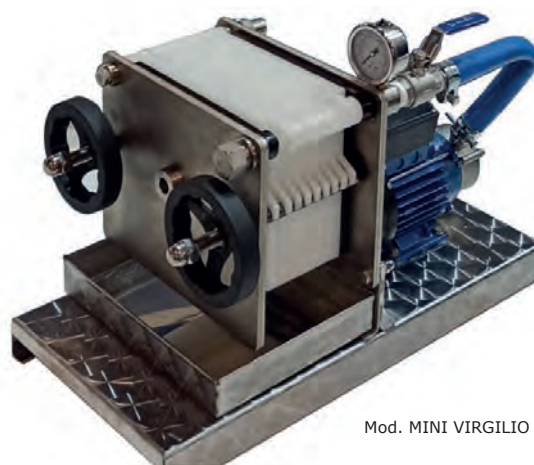

Mod. MINI VIRGILIO

STANDARD FEATURES

FILTER MINIVIRGILIO

- Frame in stainless steel AISI 304
- Plate in stainless steel and PPA dimension 20*20mm
- Pump centrifuge type ENOS 20 in stainless steel, 1,9 bar pressure
- Manometer

FILTER VIRGILIO

- Trolley in stainless steel AISI 304
- Filter plate in stainless steel and PPA, dimension 20x20
- Sample tap in stainless steel
- Stainless steel manometer

MODEL

Cod.	Description	€
901	Filter MINI VIRGILIO 6 plate (PUMP included)	
902	Filter MINI VIRGILIO 10 plate (PUMP included)	
903	Filter VIRGILIO 10 plate	
904	Filter VIRGILIO 20 plate	
905	Filter VIRGILIO 30 plate	
906	Filter VIRGILIO 40 plate	

OPTIONAL (for filter VIRGILIO)

Cod.	Description	€
9360	Difference for installation centrifuge pump ENOS 20	
9361	Difference for installation volumetric pump EURO 20	
907	Reversing plate in inox (for cod. 905 and 906)	
9362	Difference for installation centrifuge pump 1400 RPM	
9363	Difference for installation bypass on cod. 9316	

MODEL	PLATE NUMBER	CARTON DIMENSION	FILTERING SURFACE M2	WINE CAPACITY L/H	OIL CAPACITY L/H	DIMENSION MM/KG
901	6	20x20 cm	0,24	80-200	80	600x330x440/13
902	10	20x20 cm	0,4	130-280	130	600x330x440/13
903	10	20x20 cm	0,4	130-280	130	600x500x750/32
904	20	20x20 cm	0,8	600-900	300	600x500x750/36
905	30	20x20 cm	1,2	900-1500	400	600x500x750/49
906	40	20x20 cm	1,6	1400-1800	500	600x500x750/54



FILTER 40X40



Sight glass



STANDARD FEATURES

- Trolley
- Impeller pump HP 1,5 with bypass
- Sight glass
- Sample tap

MODEL

Cod.	Description	€
908	Filter 20 plate	
909	Filter 30 plate	
910	Filter 40 plate	
911	Filter 50 plate	

OPTIONAL

Cod.	Description	€
912	Kit oil for model 20-30 plate	
913	Kit oil for model 40-50 plate	
915	Reversing plate in inox	

MODEL	PLATE NUMBER	CARTON DIMENSION	FILTERING SURFACE M2	WINE CAPACITY L/H	OIL CAPACITY L/H	DIMENSION MM/KG
908	20	40x40 cm	3,2	2000	600	1200x590x950
909	30	40x40 cm	4,8	3000	700	1200x590x950
910	40	40x40 cm	6,4	4000	800	1500x590x950
911	50	40x40 cm	8,0	5000	900	1700x590x950



PUMPS



ELLIPTICAL ROTOR PUMP with loading hopper



GAMMA 180 with gear reducer 5,5 o 7,5 Hp



GAMMA 80 with gear reducer 2,5 Hp

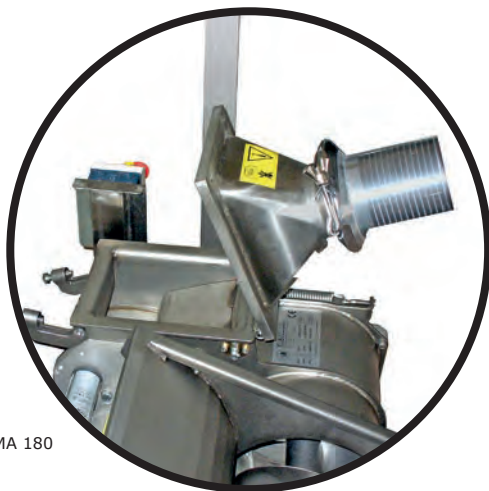

PUMP - GAMMA 180

STANDARD FEATURES

- Loading hopper with screw
- Pump with stainless steel body
- Automatic refillable lubricator (Gamma 180)
- Hinged stainless steel discharge cone, openable for inspection
- Motor three-phase (single-phase only on Gamma 80)
- CE panel control with emergency stop
- Fitting DIN female size Ø80/100 inox hose included

MODEL

Cod.	Description	€
6000	GAMMA 80 - with gear reducer HP 2	
6001	GAMMA 180 - with gear reducer HP 5,5	
6002	GAMMA 180 - with gear reducer HP 7,5	

OPTIONAL

Cod.	Description	€
6003	Curve 90° DIN 100 for pump 6001/6002	

MODEL	ENGINE HP (Kw)	HOURLY PRODUCTION	SHAFT SPEED	FITTING OUTPUT	DISCHARGE HEIGHT	DISCHARGE DISTANCE	WEIGHT
GAMMA 80	2 (1,5)	6000-8000 Kg / h	47-58 RPM	DIN 80	3 mt	10 mt	100 Kg
GAMMA 180	5,5 (4)	12000-15000 Kg / h	47-58 RPM	DIN 100	5 mt	30 mt	230 Kg
GAMMA 180	7,5 (5,5)	12000-15000 Kg / h	47-58 RPM	DIN 100	8 mt	40 mt	240 Kg



MONO PUMP with loading hopper



STANDARD FEATURES

- Loading hopper with feeding screw
- Pump body in AISI 304
- Three-phase gearmotor
- Electrical system with emergency stop
- DIN Ø 100 hose connector
- Automatic level probe on loading hopper
- Pressure 4 Bar

MODEL

Cod.	Description	€
6201	GAMMA M120 - with speed reducer 3 Kw	
6202	GAMMA M180 - with speed reducer 4 Kw	
6206	GAMMA M200 - with speed reducer 5,5 Kw	
6207	GAMMA M300 - with speed reducer 7,5 Kw	

OPTIONAL

Cod.	Description	€
6219	Electronic speed variator cod. 6201-6202-6203	
6217	Spare part stator for cod.6201	
6218	Spare part stator for cod.6202/6206	
6228	Spare part stator for cod. 6207	

MODEL	ENGINE HP (Kw)	HOURLY PRODUCTION	SHAFT SPEED	CONNECTION FITTING	HOPPER HEIGHT	DIMENSION	WEIGHT
GAMMA M120	3	10000 Kg / h	200 RPM	DIN 100	420 mm	1750x800x800 h	100 Kg
GAMMA M180	4	15000 Kg / h	144 RPM	DIN 100	450 mm	1950x930x925 h	230 Kg
GAMMA M200	5,5	20000 Kg / h	200 RPM	DIN 100	450 mm	1950x930x925 h	240 Kg
GAMMA M200	7,5	30000 Kg / h	200 RPM	DIN 125	450 mm	2020x1025x925 h	280 Kg



MONO PUMP FOR LIQUID

Cod. 6212 + 6221 + 6223

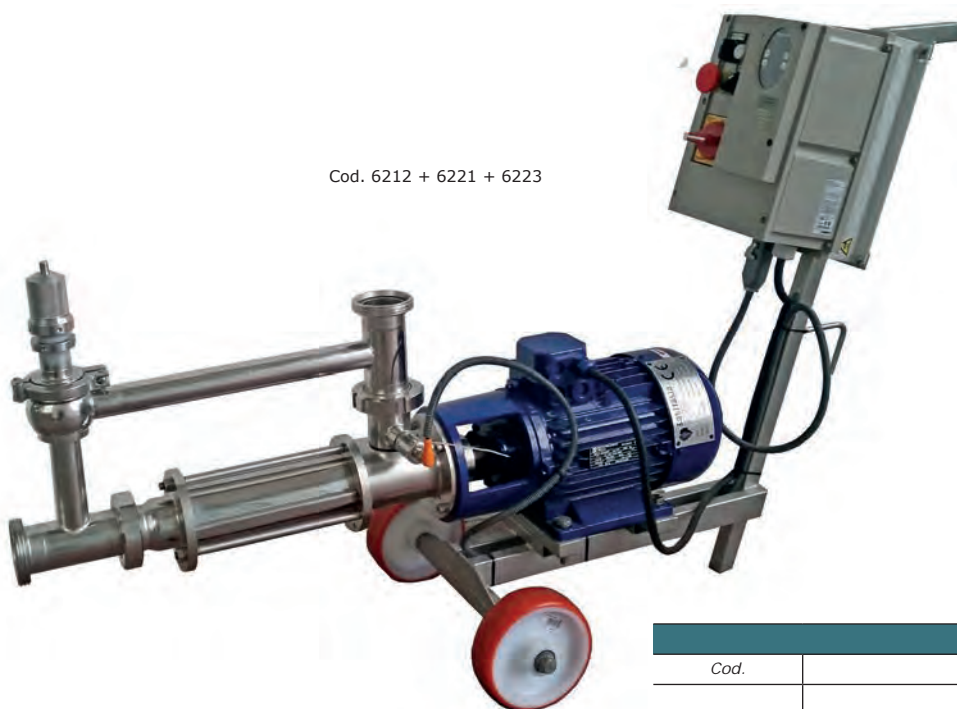

Cod. 6211



MODEL		
Cod.	Description	€
6210	GAMMA M15	
6211	GAMMA M40	
6212	GAMMA M100	

OPTIONAL		
Cod.	Description	€
6220	Electronic speed variator	
6221	By-pass valve circuit (only for code 6210-6211)	
6224	By-pass valve circuit (only for code 6212)	
6223	Dry run protection + speed variator	
6225	Spare part stator for code 6210	
6226	Spare part stator for code 6211	
6227	Spare part stator for code 6212	

STANDARD FEATURES

- Body in stainless steel
- Threephase electric motor
- CE panel control
- Fitting type DIN Ø50
- Inox trolley
- Pressure 4 bar

MODEL	ENGINE HP (Kw)	HOURLY PRODUCTION	SHAFT SPEED	CONNECTION FITTING	DIMENSION	WEIGHT
GAMMA M15	1,1	1500 Lt / h	1400 RPM	DIN 40	775x1000x400 mm	22 Kg
GAMMA M40	1,5	4000 Lt / h	900 RPM	DIN 50	775x1245x440 mm	32 Kg
GAMMA M100	2,2	10000 Lt / h	490 RPM	DIN 65	500x1650x640 mm	81 Kg



PERISTALTIC PUMP with loading hopper



STANDARD FEATURES

- 0.55 Kw motorized loading hopper with screw supply
- Pump body in AISI 304 with piping in EPDM
- Electronic speed variator
- Electrical system with emergency stop
- Automatic filling pressure switch
- Automatic level probe on hopper

MODEL		
Cod.	Description	€
6300	PP712 with loading hopper	
6301	PP713 with loading hopper	
6302	PP714 with loading hopper	
6303	PP715 with loading hopper	

OPTIONAL		
Cod.	Description	€
6305	Radio control	
6312	Spare part pipe for cod. 6300	
6313	Spare part pipe for cod. 6301	
6314	Spare part pipe for cod. 6302	
6315	Spare part pipe for cod. 6303	

MODEL	ENGINE HP (Kw)	CAPACITY WITH LIQUID	MAX CAPACITY DESTEMMED GRAPES	SHAFT SPEED	FITTING OUTPUT	HOPPER HEIGHT	DIMENSION	WEIGHT
PP712	1,5+0,55	70 Hl / h	5000 kg / h	10-75 RPM	DIN 50	420 mm	1790x750x1016 mm	170 Kg
PP713	3,0+0,55	120 Hl / h	9000 kg/ h	10-75 RPM	DIN 65	420 mm	2100x750x1186 mm	260 Kg
PP714	4,0+0,55	200 Hl / h	14000 kg/ h	10-75 RPM	DIN 65	450 mm	2245x750x1377 mm	365 Kg
PP715	5,5+0,55	260 Hl / h	18500 kg / h	10-75 RPM	DIN 65	450 mm	2332x750x1430 mm	405 Kg



PERISTALTIC PUMP *without loading hopper*

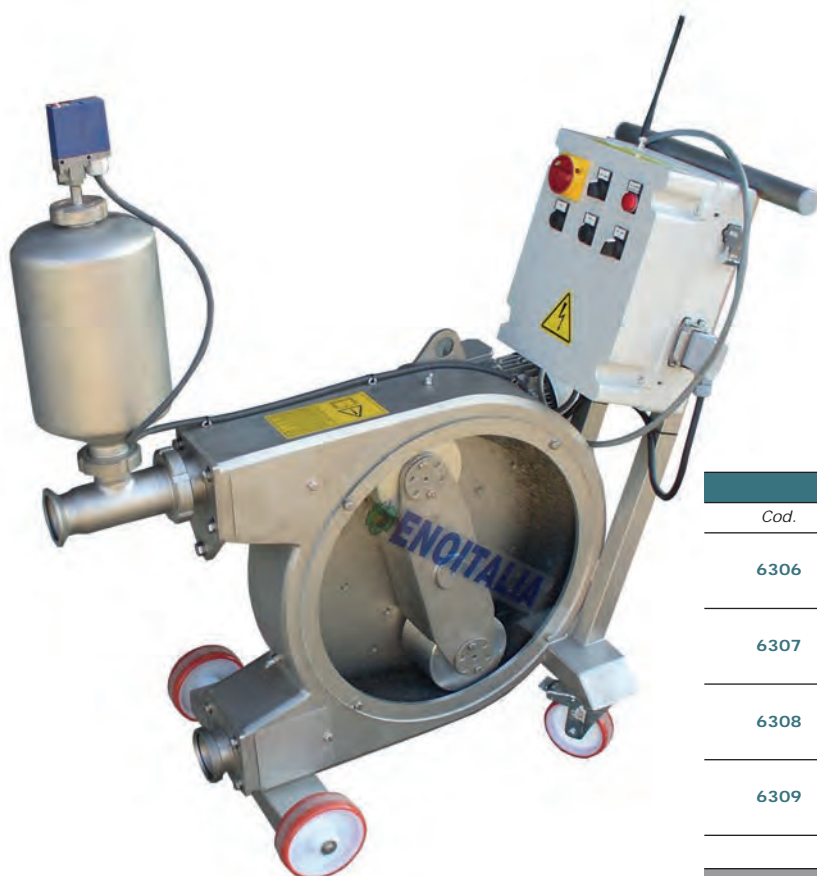

MODEL		
Cod.	Description	€
6306	PP702 for liquid	
6307	PP703 for liquid	
6308	PP704 for liquid	
6309	PP705 for liquid	

OPTIONAL		
Cod.	Description	€
6305	Radio control	
6322	Spare part pipe for cod. 6306	
6323	Spare part pipe for cod. 6307	
6324	Spare part pipe for cod. 6308	
6325	Spare part pipe for cod. 6309	

STANDARD FEATURES

- Body in stainless steel and EPDM pipe
- Electronic speed variator
- CE panel control
- N°2 compressor chambers with DIN connection
- Automatic pressure switch for filling use

MODEL	ENGINE HP (Kw)	HOURLY PRODUCTION	SHAFT SPEED	FITTING OUTPUT	PRESSURE	DIMENSION	WEIGHT
PP702	2 (1,5)	70 HI / h	10-75 RPM	DIN 50	3 bar	1035x520x1060 mm	125 Kg
PP703	4 (3)	120 HI / h	10-75 RPM	DIN 65	3 bar	1165x550x1185 mm	200 Kg
PP704	5,5 (4)	200 HI / h	10-70 RPM	DIN 65	3 bar	1365x715x1470 mm	300 Kg
PP705	7,5 (5,5)	300 HI / h	10-70 RPM	DIN 65	3 bar	1470x725x1520 mm	340 Kg



TANKS WASHING SYSTEM



Washing slide



Centrifuge pump

STANDARD FEATURES

- Frame in stainless steel AISI 304
- Garolla fitting type 40/50
- Centrifuge pump in stainless steel AISI 304 2800 rpm
- CE panel control
- Inox trolley for the pump

MODEL

Cod.	Description	€
993	Washing slide in stainless steel with anti-scratch profile and extension 700mm. Terminal sphere d.90	
994	Centrifuge pump - Hp 2 capacity 200Lt/ min at 2,5 bar (max height 3mt)	
995	Centrifuge pump - Hp 4 capacity 200 Lt/ min at 5 bar (max height 6 mt)	

MODEL	ENGINE HP (Kw)	FITTING	MAXIMUM HEIGHT TANK'S CYLINDER
994	2 (1,5) Single-phase 220V 50Hz	40/50 garolla	3 mt
995	4 (3) Three-phase 380V 60Hz	40/50 garolla	6 mt



COAXIAL PUMP *without switch and without trolley*

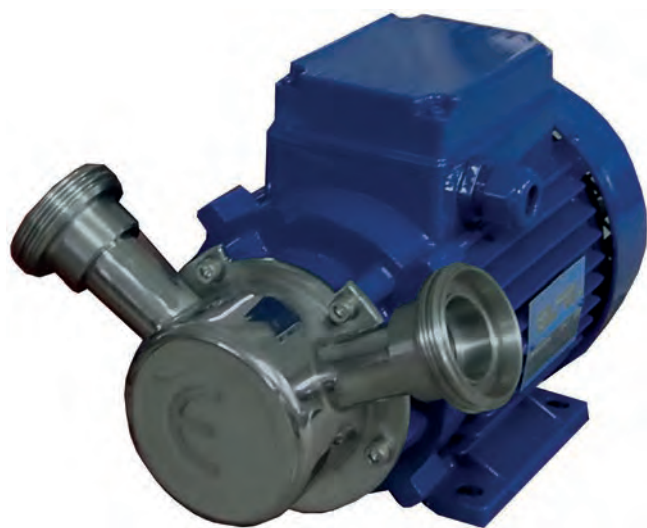

cod. 7045 Bypass



STANDARD FEATURES

- Mechanical seal Inox-Grafito-NBR
- Driving shaft in Inox AISI 304
- Rubber impeller for alimentary use type "NBSB"
- N°2 hose fittings, clamps and seals included only with garolla fitting, and BSP 3/4"
- For hot liquid higher than 60C°, demand EPDM impeller

TF = Three-phase MF = Single-phase
 * Pump with curve 90° for pump over circuit
 ** Kw conversion: IE3 0,48 = IE1 1,1
 IE3 1,1 = IE1 1,5
 *** Electronic startup capacitor

MODEL

Cod.	Description	ENGINE	HP (Kw)	Speed	Rpm	CAPACITY lt/h	Dimension	WEIGHT	€
5100	EURO 20	TF	0,5 (0,37)	1	900	1000	330x180x280 mm	6 Kg	
1101	EURO 30**	TF	0,75 (0,48)	1	900	4500	330x230x250 mm	6 Kg	
1102	EURO 30***	MF	1,5 (1,1)	1	900	4500	330x230x250 mm	6 Kg	
1103	EURO 30*	TF	0,75 (0,48)	1	900	4500	330x230x250 mm	6 Kg	
2101	EURO 40**	TF	1,5 (1,1)	1	900	9300	400x250x260 mm	18 Kg	
2103	EURO 40	TF	1,5 (1,2)	1	700	7200	400x250x260 mm	20 Kg	
3101	EURO 50	TF	2 (1,5)	1	700	10200	440x280x280 mm	17 Kg	
3102	EURO 50*	TF	2 (1,5)	1	700	10200	440x280x280 mm	17 Kg	
4101	EURO 60	TF	3 (2,2)	1	700	21000	480x300x300 mm	25 Kg	
4102	EURO 60*	TF	3 (2,2)	1	700	21000	480x300x300 mm	25 Kg	

OPTIONAL

Cod.	Description	EURO 20	EURO 30	EURO 40	EURO 50	EURO 60
7045	Bypass					



COAXIAL PUMP with switch without trolley



switch Euro 20-30-40

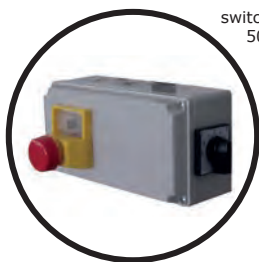

switch Euro 50-60

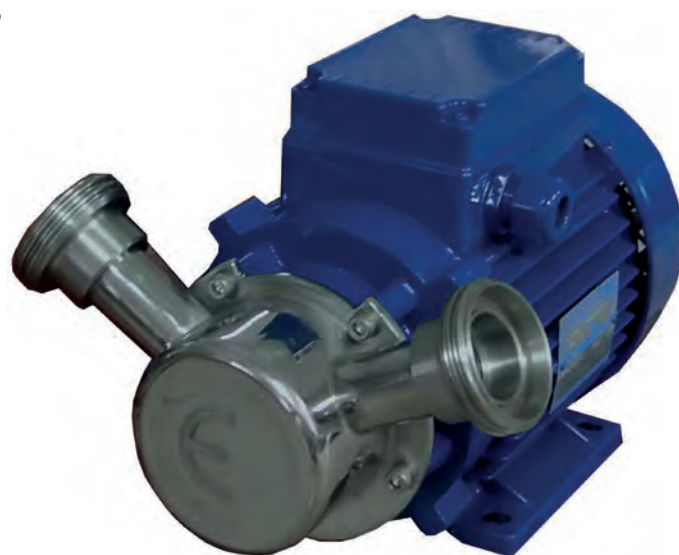

STANDARD FEATURES

- Electric system with rotation switch install on motor panel for EURO 20 - 30 - 40
- Start capacitor on single-phase version
- Mechanical seal Inox-Grafito-NBR
- Driving shaft in Inox AISI 304
- Rubber impeller for alimentary use type "NBSB"
- N°2 hose fittings, clamps and seals included only with Garolla fitting, and BSP 3/4"
- For hot liquid higher than 60C°, demand EPDM impeller
- 1,5 mt cable

TF = Three-phase MF = Single-phase

* Control panel CE separated from the motor with a 2 meters cable for EURO 50-60

** Kw conversion: IE3 0,48 = IE1 1,1

IE3 1,1 = IE1 1,5

MODEL

Cod.	Description	ENGINE	HP (Kw)	Speed	Rpm	CAPACITY lt/h	Dimension	WEIGHT	€
5201	EURO 20	MF	0,5 (0,37)	1	900	1000	330x180x280 mm	6 Kg	
5202	EURO 20	TF	0,5 (0,37)	1	900	1000	330x180x280 mm	6 Kg	
1201	EURO 30**	TF	0,75 (0,48)	1	900	4500	330x230x250 mm	10 Kg	
1202	EURO 30	MF	1,5 (1,2)	1	900	4500	330x230x250 mm	10 Kg	
2201	EURO 40**	TF	1,5 (1,1)	1	900	9300	400x250x260 mm	18 Kg	
2202	EURO 40	MF	2 (1,5)	1	900	9300	400x250x260 mm	18 Kg	
2203	EURO 40	TF	1,5 (1,2)	1	700	7200	400x250x260 mm	20 Kg	
3201	EURO 50*	TF	2 (1,5)	1	700	10200	440x280x280 mm	17 Kg	
4201	EURO 60*	TF	3 (2,2)	1	700	21000	480x300x300 mm	25 Kg	

OPTIONAL

Cod.	Description	EURO 20	EURO 30	EURO 40	EURO 50	EURO 60
7045	Bypass					
7034	CE panel control three-phase (separate control panel with two meters of cable)					
7036	CE panel control three-phase with connection 24V to install level sensor or pressure switch (separate control panel with two meters of cable)					
7047	Dry STOP kit (in addition to code 7036)					
7037	CE panel control three-phase with timer (separate control panel with two meters of cable)					



COAXIAL PUMP with trolley and switch



Switch Euro 20-30-40

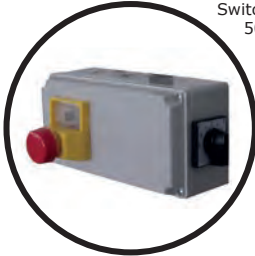

Switch Euro 50-60



TF = Three-phase MF = Single-phase
 ** Kw conversion: IE3 0,48 = IE1 1,1
 IE3 1,1 = IE1 1,5

STANDARD FEATURES

- Electric system with rotation switch install on motor
- CE panel control for pump EURO 50-60
- Start capacitor on single-phase version
- Mechanical seal Inox-Grafito-NBR
- Driving shaft in Inox AISI 304
- Trolley in stainless steel
- Rubber impeller for alimentary use type "NBSB"
- N°2 hose fittings, clamps and seals included only with Garolla fitting, and BSP 3/4"
- For hot liquid higher than 60C°, demand EPDM impeller

MODEL

Cod.	Description	ENGINE	HP (Kw)	Speed	Rpm	CAPACITY lt/h	Dimension	WEIGHT	€
5001	EURO 20	MF	0,5 (0,37)	1	900	1000	800x310x470 mm	15 Kg	
5002	EURO 20	TF	0,5 (0,37)	1	900	1000	800x310x470 mm	15 Kg	
1001	EURO 30**	TF	0,75 (0,48)	1	900	4500	800x310x470 mm	19 Kg	
1002	EURO 30	MF	1,5 (1,2)	1	900	4500	800x310x470 mm	19 Kg	
2001	EURO 40**	TF	1,5 (1,1)	1	900	9300	800x310x470 mm	21 Kg	
2002	EURO 40	MF	2 (1,5)	1	900	9300	800x310x470 mm	21 Kg	
2003	EURO 40	TF	1,5 (1,2)	1	700	7200	800x310x470 mm	23 Kg	
3001	EURO 50	TF	2 (1,5)	1	700	10200	900x360x530 mm	27 Kg	
4001	EURO 60	TF	3 (2,2)	1	700	21000	900x360x530 mm	35 Kg	
5010	EURO 80	TF	5,5 (4)	1	600	50000	1020x590x900 mm	85 Kg	

OPTIONAL

Cod.	Description	EURO 20	EURO 30	EURO 40	EURO 50	EURO 60	EURO 80
7045	Bypass						
7034	CE panel control three-phase						
7036	CE panel control three-phase with connection 24V to install level sensor or pressure switch						
7047	Dry STOP kit (in addition to code 7036)						
7037	CE panel control three-phase with fluid control and inox fitting						
7042	CE Three-phase electrical system with on / off radio control						



PUMP ON TROLLEY with belt driven



cod. 4006+704



cod. 3006



cod. 1007-2007-3007-4007

STANDARD FEATURES

- Electrical system with rotation switch and motor protection for three-phase models
- Rotation switch integrated in the motor panel for models single-phase
- Stainless steel trolley
- Stainless-Graphite-NBR mechanical seal
- Shaft in AISI 304 stainless steel
- "NBSB" type food-grade rubber impeller
- 2 hose connectors, with clamp and gasket included in the version with garolla or BSP fittings 3/4 "
- For hot liquids above 60 ° C, request an EPDM impeller

TF = Three-phase MF = Single-phase
 ** Model with gear reducer

MODEL

Cod.	Description	ENGINE	HP (Kw)	Speed	Rpm	CAPACITY lt/h	Dimension	WEIGHT	€
1007	EURO 30**	TF	1-2 (0,75-1,5)	2	430-860	2800-4500	810x410x650 mm	22 Kg	
2007	EURO 40**	TF	1-2 (0,75-1,5)	2	430-860	5500-9200	810x410x650 mm	26 Kg	
3004	EURO 50	MF	3 (2,2)	1	430	7000	830x500x810 mm	43 Kg	
3006	EURO 50	TF	2-3 (1,5-2,2)	2	400-800	7000-12000	830x500x810 mm	46 Kg	
3007	EURO 50**	TF	3-4 (2,2-3)	2	400-800	7000-12000	810x410x650 mm	40 Kg	
4004	EURO 60	MF	3 (2,2)	1	430	15000	830x500x810 mm	49 Kg	
4006	EURO 60	TF	3-4 (2,2-3)	2	400-800	15000-24000	830x500x810 mm	51 Kg	
4007	EURO 60**	TF	3-4 (2,2-3)	2	400-800	15000-24000	810x410x650 mm	48 Kg	

OPTIONAL

Cod.	Description	EURO 50	EURO 60
7045	Bypass		
7048	Difference for trolley with 4 wheels		
7036	CE panel control three-phase with connection 24V to install level sensor or pressure switch. Only three-phase model		
7047	Dry STOP kit (in addition to code 7036)		
7037	CE panel control threephase with timer		
7042	CE panel control threephase with RADIO remote control ON-OFF		



PUMP ON TROLLEY with speed variator



cod. 3011

STANDARD FEATURES

- Gear speed variator
- CE panel control
- Mechanical seal Inox-Grafite-NBR
- Trolley in stainless steel
- Driving shaft in Inox AISI 304
- Rubber impeller for alimentary use type "NBSB"
- N°2 hose fittings, clamps and seals included only with Garolla fitting, and BSP 3/4"
- For hot liquid higher than 60°C, demand EPDM impeller

MODEL

Cod.	Description	ENGINE	HP (Kw)	Rpm	CAPACITY lt/h	Dimension	WEIGHT	€
5003	EURO 20	TF	0,5 (0,37)	175-900	230-1000	550x350x600 mm	22 Kg	
1004	EURO 30	TF	1 (0,75)	175-900	1100-4500	700x410x650 mm	30 Kg	
2005	EURO 40	TF	1 (0,75)	175-900	2700-9500	700x410x650 mm	31 Kg	
3011	EURO 50	TF	2,25 (1,6)	175-900	2900-12000	810x410x650 mm	41 Kg	
4011	EURO 60	TF	2,25 (1,6)	175-900	6000-23000	810x410x650 mm	47 Kg	
5011	EURO 80	TF	5,5 (4)	150-600	12500-50000	810x410x650 mm	92 Kg	

OPTIONAL

Cod.	Description	EURO 20	EURO 30	EURO 40	EURO 50	EURO 60	EURO 80
7045	Bypass						
7036	CE panel control three-phase with connection 24V to install level sensor or pressure switch						
7047	Dry STOP kit (in addition to code 7036)						
7037	CE panel control three-phase with timer						
7042	CE panel control three-phase with RADIO remote control						



PUMP ON TROLLEY with electronic inverter

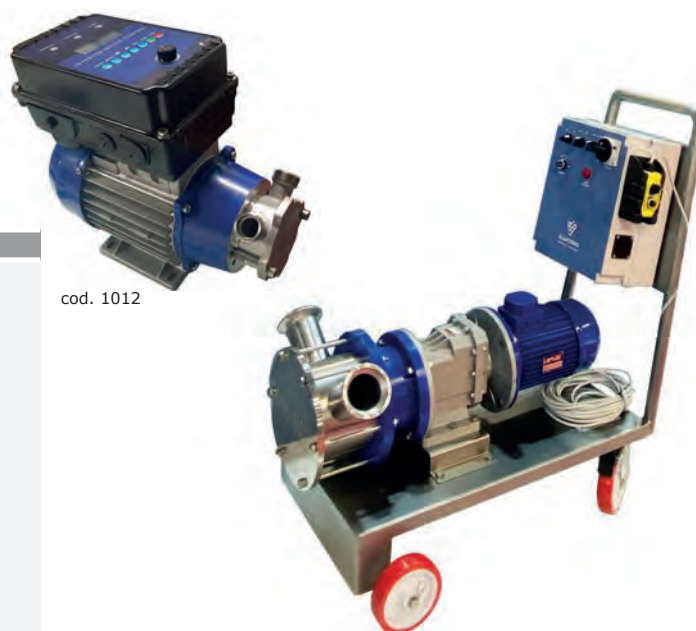

cod. 1012

STANDARD FEATURES

EQUIPMENT EURO 20

- Inox trolley
- Frequency inverter integrated
- Mechanical seal
- N.2 hose fitting BSR 3/4"

EQUIPMENT OTHER MODELS

- Engine with separate van (Euro80 and ** excluded)
- Fast plug for motor and external control
- Panel control with Loc-Rem switch
- Cord remote control 15 meter lenght
- Inox trolley with 4 wheels
- Mechanical seal Inox-Grafite-NBR
- Rubber impeller for alimentary use type "NBSB"
- N°2 hose fittings, clamps and seals included only with Garolla fitting, and BSP 3/4"
- For hot liquid higher than 60C°, demand EPDM impeller

TF = Three-phase MF = Single-phase

* default speed is set on 780 rpm

** gear reducer without separate van

*** Kw Conversion: IE3 0,48 = IE1 1,1 - IE3 1,1 = IE1 1,5

MODEL

Cod.	Description	ENGINE	HP (Kw)	Poles	Inverter HP	Rpm	CAPACITY lt/h	Dimension	WEIGHT	€
1011	EURO 20	TF	0,5 (0,37)	4	0,75 (0,44)	280-1400*	250-1600	800x310x470 mm	20 Kg	
1012	EURO 20	MF	0,5 (0,37)	4	0,75 (0,44)	280-1400*	250-1600	800x310x470 mm	20 Kg	
1008	EURO 30	TF	1 (0,75)	6	2 (1,5)	0-1000*	0-5200	740x400x650 mm	32 Kg	
1009	EURO 30	MF	1 (0,75)	6	2 (1,5)	0-1000*	0-5200	740x400x650 mm	32 Kg	
2009	EURO 40	TF	1,5 (1,1)	6	3 (2,2)	0-1000*	0-11100	1020x560x900 mm	36 Kg	
2010	EURO 40	MF	1,5 (1,1)	6	3 (2,2)	0-1000*	0-11100	1020x560x900 mm	36 Kg	
3015	EURO 50	TF	1,5 (1,1)	8	5,5 (4)	0-1000*	0-14500	1020x560x900 mm	48 Kg	
3016	EURO 50	MF	1,5 (1,1)	8	5,5 (4)	0-1000*	0-14500	1020x560x900 mm	48 Kg	
3017	EURO 50**	TF	5,5 (4)	2	5,5 (4)	0-1000*	0-14500	1100x560x1000 mm	62 Kg	
4017	EURO 60**	TF	5,5 (4)	2	5,5 (4)	0-1000*	0-24000	1100x560x1000 mm	70 Kg	
4020	EURO 60**	MF	5,5 (4)	2	5,5 (4)	0-1000*	0-24000	1100x560x1000 mm	70 Kg	
5015	EURO 80	TF	5,5 (4)	4	5,5 (4)	50-600	4000-50000	1020x590x900 mm	92 Kg	

OPTIONAL

Cod.	Description	EURO 30	EURO 40	EURO 50	EURO 60	EURO 80
7050	Radio control					
7027	Plug for external sensor 24V NC					
7047	Dry STOP kit (in addition to code 7027)					
7054	Control panel with timer					
7053	Inox panel control					



EUROFILL for dosing and counting liquid



Radiocontrol



Flowmeter ENDRESS

STANDARD FEATURES

- Volumetric pump with frequency inverter
- PLC for manual or automatic working
- Induction flowmeter Endress
- Dosing program
- Counter program
- Timer program
- Radiocontrol
- Touchscreen da 7"
- Stainless steel panel control
- Inox trolley

MODEL

Cod.	Descrizione	€
1013	EUROFILL 30	
4021	EUROFILL 60	

OPTIONAL

Cod.	Descrizione	€
7112	Stainless steel filling gun for barrique application	
7150	Automatic pressure switch for cod. 1013	
7151	Automatic pressure switch for cod. 4021	

MODEL	ENGINE KW	POWER	FITTING	CAPACITY LT/H	DIMENSION	WEIGHT
EUROFILL 30	2,2	MF/TF	Triclover 1,5"	0-5200	740x400x650	42 Kg
EUROFILL 60	4	MF/TF	Triclover 1,5"	0-24000	1100x56x1000	80Kg



CENTRIFUGAL PUMP WITH INOX BODY

Inox AISI 304



9202 - ENOS 20



9204 - ENOS 25



9206 - ENOS 30



9210 - ENOS 40

STANDARD FEATURES

- Electric system with rotation invertitors
- Mechanical seal Inox-Grafite-NBR
- Driving shaft in Inox AISI 304
- Lifting handle
- Impeller and body in stainless steel AISI 304
- N°2 fittings with hose in stainless steel and gasket
- Suitable to fill HOT LIQUID max. 90 C°
- Certificated for alimentary use

MODEL

Cod.	Description	FITTING	ENGINE	Kw	Speed	Rpm	CAPACITY lt/h	Dimension	WEIGHT	€
9202	ENOS 20	Ø 20x3/4"	MF/TF	0,33	1	2800	1680	300x230x170 mm	4,8 Kg	
9204	ENOS 25	Ø 25x1"	MF/TF	0,35	1	1400	2520	320x240x170 mm	7 Kg	
9206	ENOS 30	Ø 30x1,1/4"	MF/TF	0,88	1	1400	3900	350x240x210 mm	10 Kg	
9210	ENOS 40	Ø 40x1,1/2"	MF/TF	0,88	1	1400	5300	360x240x220 mm	11 Kg	

OPTIONAL

Cod.	Description	ENOS 20	ENOS 25	ENOS 30	ENOS 40
7223	Mechanical seals				
7224	Rubber seal disc				
7225	Handle				



OPTIONAL and SPARE PART PUMP EURO



7040 - Inox fitting



7035 - Panel control 2 speed



7042 - Panel control with radio remote control



Impeller



7038 - Automatic pressure switch



7036 - Panel control with 24 V connection



7037 - Panel control with timer







7004 - Inox Trolley









OPTIONAL							
Cod.	Description	EURO 20	EURO 30	EURO 40	EURO 50	EURO 60	EURO 80
7004	Inox trolley for coaxial type						
7006	Inox trolley for mechanical speed variator type						
7007	Inox trolley for inverter type						
7012	Impeller NBSB						
7041	Impeller CR						
7010	Impeller EPDM per liquidi superiori a 60 °C						
7023	Mechanical seal						
7031	Capacitor for single-phase motor						
7034	CE panel control 1 speed three-phase						
7035	CE panel control 2 speed threephase						
7036	CE panel control with 24 V connection three-phase						
7037	Panel control with timer Three-phase						
7042	Panel control with radio remote control						
7038	Automatic pressure switch with inox tank and inox connection (plus cod. 7039)						
7039	One way inox valve with inox connections for pump						
7032	Engine for 50Hz coaxial model						
7060	Rotative switch for single phase pump						



PUMPS FITTING

PUMPS FITTING																													
Cod.	Description																												
 <p>7015</p>	<p>DIN 11851 fitting: hose, swivel, gasket</p> <table border="1"> <thead> <tr> <th>DIN 20</th> <th>DIN 32</th> <th>DIN 40</th> <th>DIN 50</th> <th>DIN 60</th> <th>DIN 80</th> <th>DIN 100</th> </tr> </thead> <tbody> <tr> <td></td> <td></td> <td></td> <td></td> <td></td> <td></td> <td></td> </tr> </tbody> </table>	DIN 20	DIN 32	DIN 40	DIN 50	DIN 60	DIN 80	DIN 100																					
DIN 20	DIN 32	DIN 40	DIN 50	DIN 60	DIN 80	DIN 100																							
 <p>7020</p>	<p>TRICLOVER fitting: hose, gasket, nut</p> <table border="1"> <thead> <tr> <th>1 / 2"</th> <th>1,1 / 2"</th> <th>2"</th> <th>2,5"</th> <th>3"</th> </tr> </thead> <tbody> <tr> <td></td> <td></td> <td></td> <td></td> <td></td> </tr> </tbody> </table>	1 / 2"	1,1 / 2"	2"	2,5"	3"																							
1 / 2"	1,1 / 2"	2"	2,5"	3"																									
 <p>7124</p>	<p>Garolla fitting: hose, gasket, nut</p> <table border="1"> <thead> <tr> <th></th> <th>Ø 40</th> <th>Ø 50</th> <th>Ø 60</th> <th>Ø 80</th> <th>Ø 100</th> <th>Ø 120</th> </tr> </thead> <tbody> <tr> <td>Clamp</td> <td></td> <td></td> <td></td> <td></td> <td></td> <td></td> </tr> <tr> <td>Hose connector</td> <td></td> <td></td> <td></td> <td></td> <td></td> <td></td> </tr> <tr> <td>Gasket</td> <td></td> <td></td> <td></td> <td></td> <td></td> <td></td> </tr> </tbody> </table>		Ø 40	Ø 50	Ø 60	Ø 80	Ø 100	Ø 120	Clamp							Hose connector							Gasket						
	Ø 40	Ø 50	Ø 60	Ø 80	Ø 100	Ø 120																							
Clamp																													
Hose connector																													
Gasket																													
 <p>7202</p>	<p>Gas fitting: hose, swivel, gasket</p> <table border="1"> <thead> <tr> <th>3/4"</th> <th>1"</th> <th>1,1/4"</th> <th>1,1/2"</th> </tr> </thead> <tbody> <tr> <td></td> <td></td> <td></td> <td></td> </tr> </tbody> </table>	3/4"	1"	1,1/4"	1,1/2"																								
3/4"	1"	1,1/4"	1,1/2"																										

PACKING AND SHIPPING

TYPES OF PACKAGING		
	Description	€
	1 - Standard Pallet 60x80	
	2 - Standard Pallet 120x80	
	3 - Standard Pallet 200x100	
	4 - Standard Pallet 250x100	
	5 - Non-standard Pallet	
	1 - Wooden Cage 120x100x190	
	2 - Wooden Cage 200x100x180	
	3 - Wooden Cage 260x110x220	
	4 - Wooden Cage (non-standard)	

The prices refer only to the packaging. The cost of transport is excluded and depend on the size and shipping area. Direct collection from our warehouse is allowed, upon explicit request by the customer.

IMPORTANT: VERIFY THE INTEGRITY OF THE MACHINE AT THE DELIVERY, if verification is not possible, the goods must be accepted "SUBJECT TO THE UNCONDITIONED/ DAMAGED PACKAGE", otherwise it will be impossible any refund.

CONDITIONS OF GUARANTEE

The guarantee covers the machinery for the first twelve months from its activation. Should the machine not be used immediately insurance coverage is guaranteed for up to eighteen months from the date of delivery and expires thereafter. The guarantee does not cover machine transportation for which the buyer is responsible. The goods travel at the risk of the customer even if sold carriage paid. The guarantee is not applicable in case the machine is not used in accordance with the instructions contained in the manual. The repair work is understood as being ex our factory in Cerreto Guidi, (FI); transportation is at the buyer's expense.

The guarantee does not cover any defects due to the following reasons and entailing the termination of all our obligations:

- Incorrect installation.
- Tampering with the machine.
- Lack of experience, failure to carry out maintenance operations, failure to promptly notify us of any defects.
- Failure to follow the instructions contained in the manual.
- Repair work carried out by personnel not authorized by Enoitalia s.r.l.
- Transportation damage that cannot be attributed to manufacturing or packaging defects.
- Machine installation and electrical connections carried out in ways other than those indicated in the manual and to the plate located on the engine.
- Transportation expenses and risks in case the machinery is sent to authorized assistance centres.
- Electrical components.
- Consumables and ordinary maintenance costs contained in the above-mentioned manual.

The guarantee does not extend to the obligation of covering damages to individuals or things deriving from the use of our product also when broken or defective. We decline our obligations in case the payment conditions agreed are not respected.

Any complaint should be made in writing by the buyer to ENOITALIA s.r.l. within 8 days from the date of purchase.

Conditional sale: Pursuant to articles 1523-1524 of the code of civil practice, the property of the goods sold is transferred to the buyer only once the goods have been paid in full as agreed.

Any controversy shall be referred to the place of jurisdiction of Florence.

Any controversy is disciplined by the Italian law even if goods are acquired by a foreign Italian citizen or if goods are supplied to a company abroad.

ENOITALIA and ENOITALIA Group

The current ENOITALIA company was originally founded in the 1960's under the name OFFICINA ARNO. At the time, the workshop focused on building mechanical machines intended for receiving harvest wagons in which the grapes were processed with traditional destemmers and presses.

Over the years, the "Officine Arno" company, attentive to technologies and innovative with respect to the changing needs of the wine market, perfected, with innovations and patents, its production. This has led to an expansion in the selection of machines offered, characterised by specific and diverse functions. In addition to its ingenuity, the company designed and created pumps, filling machines and transport systems, which helped transform the artisanal vision of the workshop into an industrial company characterised by ongoing development.

In 1988, Officine Arno was officially transformed into ENOITALIA srl, with numerous patented products to its name (grape harvesting wagons, centrifugal pumps, stemmer-crushers, the Extravelvet system), which found great success and have been widely used in the wine market.

The professionalism and expertise acquired over the years, in addition to the application of innovative equipment and technologies, today allow ENOITALIA srl to carry out every phase of production, offering exclusive Italian machinery and manufacturing products, with a quality recognised in every market sector.

ENOITALIA srl is active in over 35 countries, with an extensive and efficient sales network, focused on ensuring consistent service and quality, exclusively Made in Italy.

In 2007 the founding members of ENOITALIA srl participated in the creation of a new company, ENOTOSCANA srl, specialized in the construction of stainless steel tanks. From the collaboration between the two companies, in 2018 a new division dedicated to the beer sector was born: ENOBEER srl.

Professionalism, expertise, service and competitiveness: these are the strengths of the ENOITALIA Group, elements that continue to ensure the growth of the company and the appreciation of its customers.





ENOITALIA

ENOLOGICAL EQUIPMENTS

Via Provinciale Pisana 162 - 50050 CERRETO GUIDI (FI) - ITALY

tel. +39 0571 588031 - fax +39 0571 588080

www.enoitalia.net - info@enoitalia.net